

MV-VC551x

VC5000 Series Vision Controller



Introduction

MV-VC551x vision controller adopts Intel® 12th processor and has DDR5 memory. It supports 32-channel GPIO and multiple-channel light source control. It also has multiple interfaces like GigE, USB 2.0, and USB 3.0. The vision controller provides solutions for vision applications, and is widely applicable to multi-camera localization, detection, and recognition, etc.

Key Feature

- Adopts 12th generation Intel® CPU to offer strong performance.
- Supports 32-channel GPIO and some models support NPN/PNP switching for output.
- Adopts GigE interfaces for stable data transmission.
- Supports multiple-channel light source for synchronous control.

Available Model

- MV-VC5513-256G70-2T (8 GB, 256 GB SSD and 2T HDD)
- MV-VC5513-256G70-NN (8 GB, 256 GB SSD)
- MV-VC5514-256G70-2T (16 GB, 256 GB SSD and 2T HDD)
- MV-VC5514-256G70-NN (16 GB, 256 GB SSD)
- MV-VC5515-256G70-2T (32 GB, 256 GB SSD and 2T HDD)
- MV-VC5515-256G70-NN (32 GB, 256 GB SSD)

Applicable Industry

Consumer electronics, food and pharmaceutical, new energy, etc.

Dimension

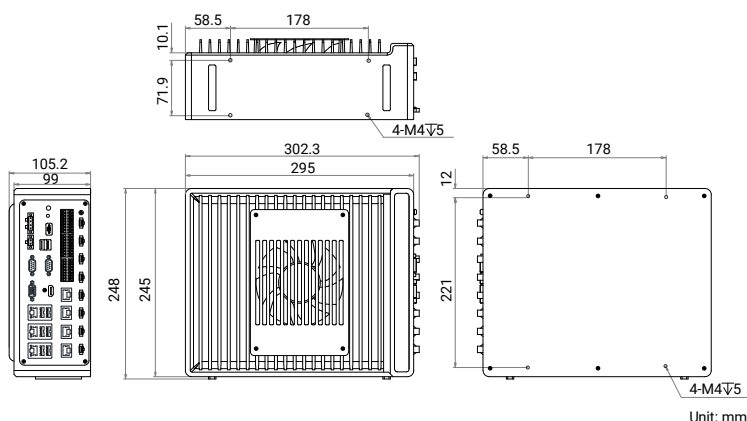

Specification

Model	MV-VC5513-256G70-2T	MV-VC5513-256G70-NN	MV-VC5514-256G70-2T	MV-VC5514-256G70-NN	MV-VC5515-256G70-2T	MV-VC5515-256G70-NN
Performance						
CPU	Intel® Core™ i5-12400					
Memory	8 GB		16 GB		32 GB	
Storage	256 GB SSD and 2T HDD	256 GB SSD	256 GB SSD and 2T HDD	256 GB SSD	256 GB SSD and 2T HDD	256 GB SSD
GPU	Intel® UHD Graphics 730					
Operating system	Unactivated Windows 10					
Chip	H610					
Interface						
Video output	HDMI interface × 1, VGA interface × 1 Supports independent display output at the same time Max. resolution 1920 × 1080 @ 60 Hz					
Digital I/O	Opto-isolated input × 8 Opto-isolated output × 12 (supports NPN/PNP switching) Digital-isolated low-side driver output × 8 Non-isolated bi-directional differential I/O × 4					
Network interface	GigE interface × 7, including interface for PoE × 4					
USB interface	USB 2.0 × 4 USB 3.0 × 4 Built-in USB 2.0 × 1					
Serial port	RS-232 × 2 by default, supports switching to RS-485 and RS-422					
Light interface	24 VDC constant voltage × 8 (Max. power consumption of single channel is 72 W, total max. power consumption 190 W)					
Extended interface	SATA 3.0 interface × 2					
Electrical feature						
Power supply	24 VDC (4-pin interface for system power supply)					
Power consumption	Typ. 264 W (4-pin interface for system power supply)					
Mechanical						
Dimension	302.3 mm × 248 mm × 105.2 mm (11.9" × 9.8" × 4.1")					
Weight	Approx. 6 kg (13.2 lb.)					
Temperature	0 °C to 45 °C (32 °F to 113 °F)	0 °C to 50 °C (32 °F to 122 °F)	0 °C to 45 °C (32 °F to 113 °F)	0 °C to 50 °C (32 °F to 122 °F)	0 °C to 45 °C (32 °F to 113 °F)	0 °C to 50 °C (32 °F to 122 °F)
Humidity	20% RH to 95% RH (no condensation)					
General						
Certification	CE, KC					