

Hikrobot Co., Ltd.

CT Series USB 3.0 Area Scan Camera

User Manual

HIKROBOT

Legal Information

© Hangzhou Hikrobot Co., Ltd. All rights reserved.

About this Document

This Document includes instructions for using and managing the Product. Pictures, charts, images and all other information hereinafter are for description and explanation only. The information contained in the Document is subject to change, without notice, due to firmware updates or other reasons. Please find the latest version in the company website (<https://en.hikrobotics.com/>). Unless otherwise agreed, Hangzhou Hikrobot Co., Ltd. or its affiliates (hereinafter referred to as "Hikrobot") makes no warranties, express or implied. Please use the Document with the guidance and assistance of professionals trained in supporting the Product.

Acknowledgment of Intellectual Property Rights

- Hikrobot owns the copyrights and/or patents related to the technology embodied in the Products described in this Document, which may include licenses obtained from third parties. Any part of the Document, including text, pictures, graphics, etc., belongs to Hikrobot. No part of this Document may be excerpted, copied, translated, or modified in whole or in part by any means without written permission.
- **HIKROBOT** and other Hikrobot's trademarks and logos are the properties of Hikrobot in various jurisdictions. Other trademarks and logos mentioned are the properties of their respective owners.

LEGAL DISCLAIMER

TO THE MAXIMUM EXTENT PERMITTED BY APPLICABLE LAW, THIS MANUAL AND THE PRODUCT DESCRIBED, WITH ITS HARDWARE, SOFTWARE AND FIRMWARE, ARE PROVIDED "AS IS" AND "WITH ALL FAULTS AND ERRORS". HIKROBOT MAKES NO WARRANTIES, EXPRESS OR IMPLIED, INCLUDING WITHOUT LIMITATION, MERCHANTABILITY, SATISFACTORY QUALITY, OR FITNESS FOR A PARTICULAR PURPOSE. THE USE OF THE PRODUCT BY YOU IS AT YOUR OWN RISK. IN NO EVENT WILL HIKROBOT BE LIABLE TO YOU FOR ANY SPECIAL, CONSEQUENTIAL, INCIDENTAL, OR INDIRECT DAMAGES, INCLUDING, AMONG OTHERS, DAMAGES FOR LOSS OF BUSINESS PROFITS, BUSINESS INTERRUPTION, OR LOSS OF DATA, CORRUPTION OF SYSTEMS, OR LOSS OF DOCUMENTATION, WHETHER BASED ON BREACH OF CONTRACT, TORT (INCLUDING NEGLIGENCE), PRODUCT LIABILITY, OR OTHERWISE, IN CONNECTION WITH THE USE OF THE PRODUCT, EVEN IF HIKROBOT HAS BEEN ADVISED OF THE POSSIBILITY OF SUCH DAMAGES OR LOSS.

YOU ACKNOWLEDGE THAT THE NATURE OF INTERNET PROVIDES FOR INHERENT SECURITY RISKS, AND HIKROBOT SHALL NOT TAKE ANY RESPONSIBILITIES FOR ABNORMAL OPERATION, PRIVACY LEAKAGE OR OTHER DAMAGES RESULTING FROM CYBER-ATTACK, HACKER ATTACK, VIRUS INFECTION, OR OTHER INTERNET SECURITY RISKS; HOWEVER, HIKROBOT WILL PROVIDE TIMELY TECHNICAL SUPPORT IF REQUIRED.

YOU AGREE TO USE THIS PRODUCT IN COMPLIANCE WITH ALL APPLICABLE LAWS, AND

YOU ARE SOLELY RESPONSIBLE FOR ENSURING THAT YOUR USE CONFORMS TO THE APPLICABLE LAW. ESPECIALLY, YOU ARE RESPONSIBLE, FOR USING THIS PRODUCT IN A MANNER THAT DOES NOT INFRINGE ON THE RIGHTS OF THIRD PARTIES, INCLUDING WITHOUT LIMITATION, RIGHTS OF PUBLICITY, INTELLECTUAL PROPERTY RIGHTS, OR DATA PROTECTION AND OTHER PRIVACY RIGHTS. YOU SHALL NOT USE THIS PRODUCT FOR ANY PROHIBITED END-USES, INCLUDING THE DEVELOPMENT OR PRODUCTION OF WEAPONS OF MASS DESTRUCTION, THE DEVELOPMENT OR PRODUCTION OF CHEMICAL OR BIOLOGICAL WEAPONS, ANY ACTIVITIES IN THE CONTEXT RELATED TO ANY NUCLEAR EXPLOSIVE OR UNSAFE NUCLEAR FUEL-CYCLE, OR IN SUPPORT OF HUMAN RIGHTS ABUSES.

THE PERFORMANCE DATA IN THIS PUBLICATION IS BASED ON HIKROBOT'S INTERNAL RESEARCH/EVALUATION. ACTUAL DATA MAY VARY DEPENDING ON SPECIFIC CONFIGURATIONS AND OPERATING CONDITIONS AND HIKROBOT SHALL NOT BEAR THE CONSEQUENCES ARISING THEREFROM.

IN THE EVENT OF ANY CONFLICTS BETWEEN THIS MANUAL AND THE APPLICABLE LAW, THE LATTER PREVAILS.

Regulatory Information



Note

These clauses apply only to the products bearing the corresponding mark or information.

EU Conformity Statement



This product and - if applicable - the supplied accessories too are marked with "CE" and comply therefore with the applicable harmonized European standards listed under the Directive 2014/30/EU(EMCD), Directive 2001/95/EC(GPSD) and Directive 2011/65/EU(RoHS).



2012/19/EU (WEEE directive): Products marked with this symbol cannot be disposed of as unsorted municipal waste in the European Union. For proper recycling, return this product to your local supplier upon the purchase of equivalent new equipment, or dispose of it at designated collection points. For more information see: <http://www.recyclethis.info>



Regulation (EU) 2023/1542(Battery Regulation): This product contains a battery and it is in conformity with the Regulation (EU) 2023/1542. The battery cannot be disposed of as unsorted municipal waste in the European Union. See the product documentation for specific battery information. The battery is marked with this symbol, which may include lettering to indicate cadmium (Cd), or lead (Pb). For proper recycling, return the battery to your supplier or to a designated collection point. For more information see: www.recyclethis.info.



KC Mark Certification

Class A: The device is advised to note that as a seller or a business user (Class A) Devices and intended for use outside the Home area.

A급 기기: 이 기기는 업무용(A급) 전자파적합기기로서 판매자 또는 사용자는 이 점을 주의하시기바라며, 가정 외의 지역에서 사용하는 것을 목적으로 합니다.

Symbol Conventions

The symbols that may be found in this document are defined as follows.

Symbol	Description
 Danger	Indicates a hazard with a high level of risk, which if not avoided, will result in death or serious injury.
 Caution	Indicates a potentially hazardous situation which, if not avoided, could result in equipment damage, data loss, performance degradation, or unexpected results.
 Note	Provides additional information to emphasize or supplement important points of the main text.

Available Model

This manual is applicable to the CT Series USB 3.0 Area Scan Camera.

Contact Information

Hangzhou Hikrobot Co., Ltd.

E-mail: global.support@hikrobotics.com

Website: <https://en.hikrobotics.com/>

Contents

Chapter 1 Safety Instruction	1
1.1 Safety Claim.....	1
1.2 Safety Instruction.....	1
1.3 Electromagnetic Interference Prevention	3
Chapter 2 Cleaning Instruction	4
2.1 Device and Lens Cleaning.....	4
2.1.1 Rubber Dust Air Blower.....	4
2.1.2 Mirror Brush Cleaning.....	5
2.1.3 Lens Wiping.....	5
2.1.4 Lens Cleaning Paper	6
2.2 Device Housing Cleaning	7
Chapter 3 Overview	8
3.1 Introduction.....	8
3.2 Operating Principle.....	8
Chapter 4 Device Hardware	10
4.1 Appearance	10
4.2 Power and I/O Connector.....	11
4.3 Indicator.....	12
Chapter 5 Power Supply and Heat Dissipation	13
5.1 Device Power Supply	13
5.1.1 USB Power Supply.....	13
5.1.2 DC Power Supply	13
5.2 Heat Dissipation.....	14
5.2.1 Temperature Parameter	14
5.2.2 Heat Dissipation Measures	16
5.2.3 Low Heat Conduction Material.....	17
Chapter 6 Accessories	19
6.1 Lens	19
6.1.1 Lens Mount	19

6.1.2 Lens Selection	19
6.2 Lens Cap	20
6.3 Cable.....	20
6.3.1 Cable Selection.....	20
6.3.2 Wiring Principle	21
Chapter 7 Quick Start Guide	24
7.1 Device Installation	25
7.1.1 Installation Preparation	25
7.1.2 Install Device.....	26
7.2 Install Client Software	28
7.3 Check Driver	30
7.4 Basic Operation	31
Chapter 8 I/O Electrical Features and Wiring.....	33
8.1 I/O Electrical Features	33
8.1.1 Input Signal	33
8.1.2 Output Signal	34
8.1.3 Bi-Directional Signal.....	36
8.1.4 Factors Affecting Transmission Delay of I/O Lines.....	39
8.2 I/O Wiring	40
8.2.1 Input Signal Wiring	40
8.2.2 Output Signal Wiring.....	41
8.2.3 Bi-Directional Signal Wiring.....	43
Chapter 9 Trigger Input and Output	45
9.1 Trigger Input.....	45
9.1.1 Set Trigger Mode	45
9.1.2 Set Trigger Source	46
9.1.3 Set Trigger Related Parameters	50
9.1.4 Set Counting.....	56
9.2 Trigger Output	59
9.2.1 Enable Line Inverter	59
9.2.2 Enable Strobe Signal.....	60

Chapter 10 Image Acquisition and Transmission	66
10.1 Global Shutter and Rolling Shutter	66
10.1.1 Global Shutter	66
10.1.2 Rolling Shutter.....	66
10.2 Acquisition Mode	68
10.3 Acquisition Burst Mode	68
10.4 Set Frame Rate	69
Chapter 11 Image Parameter	71
11.1 Set Resolution and ROI	71
11.2 Set Image Reverse	72
11.3 Set Rotation	73
11.4 Set Pixel Format	73
11.5 Set Image Compression Mode	75
11.5.1 Set Lossless Compression Mode	75
11.5.2 Set Lossy Compression Mode.....	76
11.6 Set Test Pattern	76
11.7 Set Binning	77
11.8 Set Decimation	78
11.9 Set Exposure Mode	79
11.10 Set Gain	80
11.10.1 Set Analog Gain	81
11.10.2 Set Digital Gain.....	81
11.11 Set Brightness	82
11.12 Set Sharpness	82
11.13 Set Contrast Ratio	83
11.14 Set LCE Mode	83
11.15 Set White Balance	84
11.16 Set Sequencer	86
11.17 User Set Customization	88
11.17.1 Save User Set	88
11.17.2 Load User Set	89
11.17.3 Set User Default	90

Chapter 12 Advanced Functions	91
12.1 Set Sensor Mode	91
12.2 Set Black Level	91
12.3 Set Gamma Correction.....	92
12.4 Set Digital Noise Reduction	93
12.5 Set AOI	94
12.6 Set CCM	94
12.6.1 Set Hue	96
12.6.2 Set Saturation	97
12.7 Set Super Palette Control	98
12.8 Set Automatic Color Correction	98
12.9 Set LUT	100
12.10 Set CLUT	101
12.11 Set LSC Correction	102
12.12 Set PFC	103
12.13 Set Heat Balance	104
12.14 Set Event Control.....	105
12.15 Set Transfer Control	107
Chapter 13 Other Functions	109
13.1 Device Control	109
13.2 Transport Layer Control	111
13.3 U3V Protocol Control	112
13.4 Embedded Information	113
13.5 File Access Control.....	115
13.6 Update Firmware	116
13.7 Device Encryption via Dongle Tool	117
Chapter 14 FAQ (Frequently Asked Question)	119
14.1 Why the client software cannot list devices?.....	119
14.2 Why device connection fails after the device is listed in the client software?	119
14.3 Why the live view is black?	119
14.4 Why the device cannot be triggered although the live view is normal?.....	119
14.5 Why the device cannot get images required by the algorithm although live view	

and trigger signal are normal?	120
14.6 Why the device is disconnected during operation?.....	120
Chapter 15 Revision History	121
Appendix A Device Parameter Index	122
A.1 Device Control.....	122
A.2 Image Format Control.....	123
A.3 Acquisition Control.....	124
A.4 Software Signal Control.....	125
A.5 Analog Control	125
A.6 Color Transformation Control	127
A.7 Super Palette Control	127
A.8 LUT Control.....	127
A.9 Shading Correction.....	128
A.10 Digital IO Control	128
A.11 Counter and Timer Control	129
A.12 File Access Control.....	129
A.13 Sequencer Control.....	130
A.14 Event Control	130
A.15 Chunk Data Control	131
A.16 Transport Layer Control.....	131
A.17 Stream Control.....	132
A.18 Transfer Control	132
A.19 User Set Control	132

Chapter 1 Safety Instruction

The safety instructions are intended to ensure that the user can use the device correctly to avoid danger or property loss. Read and follow these safety instructions before installing, operating and maintaining the device.

1.1 Safety Claim

- To ensure personal and device safety, when installing, operating, and maintaining the device, follow the signs on the device and all safety instructions described in the manual.
- The note, caution and danger items in the manual do not represent all the safety instructions that should be observed, but only serve as a supplement to all the safety instructions.
- The device should be used in an environment that meets the design specifications, otherwise it may cause malfunctions, and malfunctions or component damage caused by non-compliance with relevant regulations are not within the scope of the device's quality assurance.
- Our company will not bear any legal responsibility for personal safety accidents and property losses caused by abnormal operation of the device.

1.2 Safety Instruction

Caution:

- Do not install the device if it is found that the device and accessories are damaged, rusted, water ingress, model mismatch, missing parts, etc., when unpacking.
- Avoid storage and transportation in places such as water splashing and rain, direct sunlight, strong electric fields, strong magnetic fields, and strong vibrations.
- Avoid dropping, smashing or vigorously vibrating the device and its components.
- It is forbidden to install the indoor device in an environment where it may be exposed to water or other liquids. If the device is damp, it may cause fire and electric shock hazard.
- Place the device in a place out of direct sunlight and ventilation, away from heat sources such as heaters and radiators.
- In the use of the device, you must be in strict compliance with the electrical safety regulations of the nation and region.
- Use the power adapter provided by the official manufacturer. The power adapter must meet the Limited Power Source (LPS) requirements. For the specific power consumption of the device, please refer to the device's specifications.
- Do not cover the device's plug or outlet for disconnecting power supply.
- It is strictly forbidden to wire, maintain, and disassemble the device is powered on.

Otherwise, there is a danger of electric shock.

- If the device emits smoke, odor or noise, please turn off the power and unplug the power cord immediately, and contact the dealer or service center in time.
- It is strictly forbidden to touch any terminal of the device when operating it. Otherwise there is a danger of electric shock.
- It is strictly forbidden for non-professional technicians to detect signals during device operation, otherwise it may cause personal injury or device damage.
- It is strictly forbidden to maintain the device is powered on, otherwise there is a danger of electric shock.
- Avoid aiming the lens at strong light (such as lighting, sunlight, or laser beams, etc.), otherwise the image sensor will be damaged.
- Keep clean of the device's image acquisition window. It is recommended to use cleaning water (not the alcohol-based corrosive solutions) to wipe off the dust. When the device is not in use, please add a dust cover to protect the image acquisition window.
- If the device does not work properly, please contact your dealer or the nearest service center. Never attempt to disassemble the device yourself (we shall not assume any responsibility for problems caused by unauthorized repair or maintenance).
- Please dispose of the device in strict accordance with the relevant national or regional regulations and standards to avoid environmental pollution and property damage.

Note:

- Check whether the device's package is in good condition, whether there is damage, intrusion, moisture, deformation, etc. before unpacking.
- Check the surface of the device and accessories for damage, rust, bumps, etc. when unpacking.
- Check whether the quantity and information of the device and accessories are complete after unpacking.
- Store and transport the device according to the storage and transport conditions of the device, and the storage temperature and humidity should meet the requirements.
- It is strictly prohibited to transport the device in combination with items that may affect or damage the device.
- Quality requirements for installation and maintenance personnel:
 - Qualification certificate or working experience in weak current system installation and maintenance, and relevant working experience and qualifications. Besides, the personnel must possess the following knowledge and operation skills.
 - The basic knowledge and operation skills of low voltage wiring and low voltage electronic circuit connection.
 - The ability to comprehend the contents of this manual.
- Please read the manual and safety instructions carefully before installing the device.
- Please install the device strictly according to the installation method in this manual.
- The case of the device may be overheated, and it needs to be powered off for half an hour before it can be touched.
- The device should not be placed with exposed flame sources, such as lighted candles.

1.3 Electromagnetic Interference Prevention

- Make sure that the shielding layer of cables is intact and 360° connected to the metal connector when using shielded cables.
- Do not route the device together with other equipment (especially servo motors, high-power devices, etc.), and control the distance between cables to more than 10 cm. Make sure to shield the cables if unavoidable.
- The control cable of the device and the power cable of the industrial light source must be wired separately to avoid bundled wiring.
- The power cable, data cable, signal cable, etc. of the device must be wired separately. Make sure to ground them if the wiring groove is used to separate the wiring and the wiring groove is metal.
- During the wiring process, evaluate the wiring space reasonably, and do not pull the cables hard, so as not to damage the electrical performance of the cables.
- If the device is powered on and off frequently, it is necessary to strengthen the voltage isolation, and consider adding a DC/DC isolation power supply module between the device and the adapter.
- Use the power adapter to supply power to the device separately. If centralized power supply is necessary, make sure to use a DC filter to filter the power supply of the device separately before use.
- The unused cables of the device must be insulated.
- When installing the device, if you cannot ensure that the device itself and all equipment connected to the device are well grounded, you should isolate the device with an insulating bracket.
- To avoid the accumulation of static electricity, ensure that other equipment (such as machines, internal components, etc.) and metal brackets on site are properly grounded.
- During the installation and use of the device, high voltage leakage must be avoided.
- Use a figure-eight bundle method if the device cable is too long.
- When connecting the device and metal accessories, they must be connected firmly to maintain good conductivity.

Chapter 2 Cleaning Instruction

2.1 Device and Lens Cleaning

Four ways are available to clean the device and lens when they have dust or stains. Refer to the following table for different devices and their supported cleaning methods.

Table 2-1 Device and Cleaning Method

Cleaning Method	Device	
	Camera	Lens
Rubber Dust Air Blower	Support	Support
Mirror Brush Cleaning	Not Support	Support
Lens Wiping	Support	Support
Lens Cleaning Paper	Not Support	Support

2.1.1 Rubber Dust Air Blower

You can use a rubber dust air blower to clean the dust on the surface of the device filter and lens. The specific operation steps are as follows:

Steps

1. Blow the rubber dust air blower downward several times to blow out the dust inside.
2. Hold the device or lens and tilt it down so that the air blower port and the device lens are at an angle of 45 degrees.
3. Blow to clean the dust on the surface of the device filter and lens.



Figure 2-1 Cleaning by Rubber Dust Air Blower

Note

- Do not go too far into the device's lens mount and avoid direct contact with the dust glass when cleaning.
 - It is strictly forbidden to blow the lens directly from the mouth, and avoid spattering saliva particles onto the glass surface, causing serious secondary pollution.
-

2.1.2 Mirror Brush Cleaning

If the dust on the surface of the lens cannot be cleaned by rubber dusk air blower, use a mirror brush to gently remove the dust on the surface of the lens.

Note

Do not touch the bristles directly with your hands.

2.1.3 Lens Wiping

For the stubborn stains on device filter or lens surface, such as finger marks, liquid stains, etc., it is recommended to use a fat-free cotton swab or dust-free cloth with high purity alcohol to wipe clean. Take the fat-free cotton swab as an example, and the specific operation steps are as follows:

Steps

1. Take a clean fat-free cotton swab, and dip it in proper amount of alcohol or cleaning liquid.
-

Note

Do not touch the head of the cotton swab by fingers.

2. Tilt the fat-free cotton swab about 60 degrees, resist the device filter or lens surface, clean from left to right, turn cotton swab over one side, and clean again from right to left.
3. Take another fat-free cotton swab that is not stained with alcohol or cleaning liquid and swipe the device filter or lens to absorb the remaining alcohol or cleaning liquid.
4. Check whether there is still a stain. If the stain changes position, repeat steps above, until the stain is cleaned.



Figure 2-2 Contact Cleaning

Note

If the stains on the lens cannot be wiped or clean, please clean by using lens cleaning paper. For specific operation steps, please refer to the next section.

2.1.4 Lens Cleaning Paper

For lens stains that cannot be cleaned by a fat-free cotton swab or dust-free cloth, use lens cleaning paper to clean them.

Before You Start

- Use lens paper purchased from a regular, professional photography store.
- Use freshly opened lens cleaning paper in a wet state.
- Make sure there is no hard dust on the lens.

Tear off the outer package of the lens cleaning paper, fold the pre-moistened paper to a suitable wiping state, and slowly spiral wipe it in the same direction from the center of the lens outward.

Note

- Do not use hard paper, paper towels, or napkins to clean the lens. These products contain scratching wood pulp, which will seriously damage delicate coating on the lens.
 - Do not press the lens surface hard when cleaning it the lens cleaning paper. Otherwise, the fragile coating on the lens surface will be wiped off.
-

After completing the lens cleaning, no dust or water stains should be visible from all directions on the lens. If stains still exist, please contact us to return the device for cleaning.

2.2 Device Housing Cleaning

When cleaning the device, try to clean it in a closed room to avoid a large amount of dust in the environment. The specific operation steps are as follows:

Steps

1. Disconnect the device's power supply.
2. Take a soft lint-free cloth that will not cause static electricity during cleaning and soak it with a neutral detergent.
3. Wipe the device's housing with a soaked, lint-free cloth as appropriate.
4. Wait for the residual moisture to evaporate after wiping. When the moisture has completely evaporated, you can reconnect the device to the power supply.

Note

Do not use compressed air to accelerate evaporation.

After inspecting and confirming that the device lens and its housing are cleaned, install the device lens cap with the mount facing downwards, or store the lens properly.

Chapter 3 Overview

3.1 Introduction

Designed for industrial applications, the CT series USB 3.0 area scan camera adopts Type-C interface for real-time transmission, and offers industry-leading performance and reliability, with various versions (BASE/PRO) to meet diverse application needs. Some device versions support IP67 protection, expanded interfaces, and integration of liquid/electric lens, light source, and lens cap, creating a more flexible and efficient system.

Table 3-1 Function Comparison

Version	Image Process	Temperature Control	Integrated Control	Ingress Protection	Applicable Scenarios
BASE	Basic functions	Not support	Not support	IP40	Standard vision inspection in dry environment
PRO	<ul style="list-style-type: none"> • Basic functions • Advanced functions (color correction, etc.) 	Support precision temperature control design.	Not support	IP67	<ul style="list-style-type: none"> • Dusty and humid environment • Color temperature variation scenarios • Temperature drift-sensitive scenarios • High color reproduction scenarios

 **Note**

The Ingress Protection of the device is valid only when the lens or lens cap is properly installed and all cables are correctly connected.

3.2 Operating Principle

The onboard block diagram of the device is shown below. After the image sensor receives the image data, it completes the image data processing through various built-in ISP image-processing algorithms, and finally completes the high-speed transmission of image data through the USB 3.0 interface.

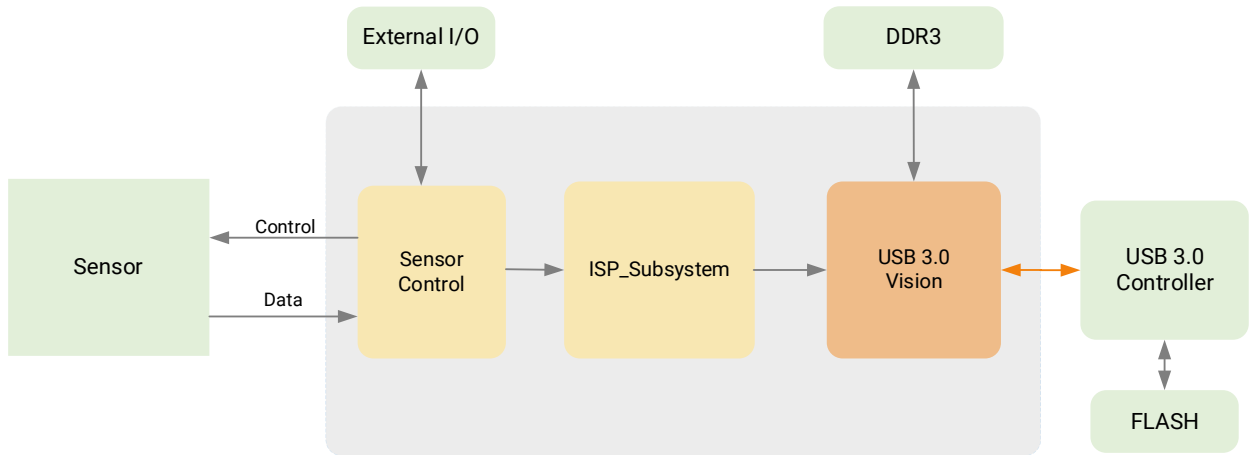

Figure 3-1 Operating Principle

Chapter 4 Device Hardware

4.1 Appearance

Note

- The device's appearance may differ by device models. The images below are for reference only. For specific appearance and dimension, please refer to the device's specification for details.
- The appearance is subject to change, and the actual device you purchased shall prevail.

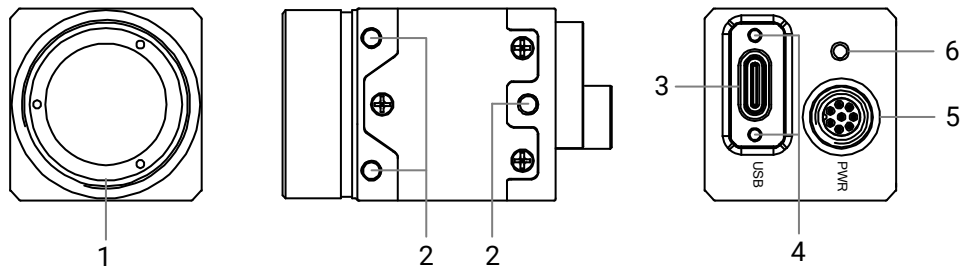

Figure 4-1 Appearance of Device Interface

Table 4-1 Component Description

No.	Component	Description
1	Lens Mount	It is used to install the lens. Refer to the device's datasheet for specific lens mount information.
2	Screw Hole	It refers to the M3 screw hole for fixing the device to the installation position. The screw holes are located on the top, bottom, or side of the device.
3	Type-C Interface (USB)	It refers to the Type-C interface for data transmission and power supply.
4	Screw Hole of Type-C Interface	It refers to the M2 screw hole for fixing the Type-C cable. You need to tighten the screws to ensure the waterproof function of the PRO version device's interface.
5	Power and I/O Connector (PWR)	It refers to 8-pin M8 A-Code connector, providing power supply and I/O function. Refer to section Power and I/O Connector for details.
6	LED Indicator	It indicates the device's status. Refer to section Indicator for details.

4.2 Power and I/O Connector

The device has an 8-pin M8 A-Code connector as the power and I/O connector that provides power supply and I/O function.

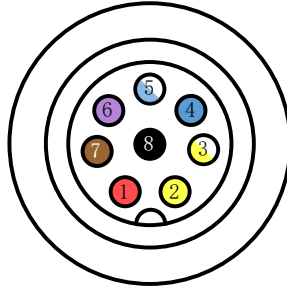

Figure 4-2 8-Pin M8 A-Code Connector

Table 4-2 Pin Definitions of 8-Pin M8 A-Code Connector

No.	Color	Signal	I/O Signal Source	Description
1	Red	DC_PWR	--	Device power supply
2	Yellow	OPTO_IN+	Line 0+	Opto-isolated input positive
3	White/Yellow	OPTO_IN-	Line 0-	Opto-isolated input negative
4	Blue	OPTO_OUT+	Line 1+	Opto-isolated output positive
5	White/Blue	OPTO_OUT-	Line 1-	Opto-isolated output negative
6	Purple	/	/	/
7	Brown	GPIO	Line 2+	Bi-directional configurable input/output
8	Black	GND	Line 2-	Device power supply ground

Note

- Refer to the table above and the label attached to the power and I/O cable to wire the device.
- The wire cores shown in the figure and table above are only the wire sequence and the corresponding wire core color of the cables sold by our company. If the cables are not purchased from our company, please refer to the actual wire sequence and the corresponding wire core color.

4.3 Indicator

The device's indicator is used to indicate the operation status of the device.

Note

- The indicator status may differ by device models, and actual devices you purchased shall prevail.
- When the indicator is lit up, flashing rapidly, flashing slowly, or flashing very slowly, its unlit interval is 8 sec, 0.2 sec to 0.3 sec, 1 sec, or 2 sec respectively.
- The indicator sometimes may show a purple color when red and blue colors flashing at the same time.

Table 4-3 Indicator Description

No.	Indicator Color	Status	Device Status Description
1	Red	Flashing very slowly	The data cable is disconnected.
2	Blue	Solid	The device is in idle status. The data cable is connected, and the device is ready.
3	Blue	Flashing rapidly	The data cable is connected, and the device is acquiring images in the internal trigger mode. Data transmission speed reaches the rated speed of USB 3.0.
4	Blue	Flashing slowly	The data cable is connected, and the device is acquiring images in the internal trigger mode. Data transmission speed reaches the rated speed of USB 2.0.
5	Blue	Flashing very slowly	The data cable is connected, and the device is acquiring images in the external trigger mode.
6	Red and blue	Flashing in alternative	The function of finding me is executed, or the firmware is updating.

Chapter 5 Power Supply and Heat Dissipation

5.1 Device Power Supply

The device provides two ways of power supply: USB power supply and external DC power supply.

When the external DC power supply and USB power supply are executed at the same time, the DC power supply takes priority. If the DC power supply is disconnected, the device will switch to USB power supply and may restart.

5.1.1 USB Power Supply

You can connect the device's Type-C interface and the USB interface on industrial PC via the USB 3.0 Standard-A to Type-C cable for power supply.

5.1.2 DC Power Supply

Connect the external DC power supply to the I/O connector through the I/O cable to power the device. Refer to the device's label for the specific voltage range of power supply.

Note

- Using a DC power supply that exceeds the specified voltage range may cause damage or abnormal operation of the device.
 - Inserting a connector that does not match the I/O connector may cause damage or abnormal operation of the device. Refer to section [Power and I/O Connector](#) for details.
 - Do not short-circuit the power supply and ground.
-

You can use an industrial power supply to provide DC power supply for the device. When using it, please observe the following precautions:

- Before carrying out any installation or maintenance work, make sure that the power supply is disconnected from the AC power and that there is no risk of accidental reconnection due to human negligence or wiring issues.
- Do not install the power supply in a humid environment, near liquid, in high-temperature conditions, in direct sunlight, or near flame sources.
- The industrial power supply has exposed high-voltage terminals. Please install it in an enclosed case or cabinet to prevent accidental contact by personnel.
- Maintain sufficient insulation distance between the internal components of the power supply and the screws.
- Ensure that the cooling fan and holes for heat dissipation are unobstructed. If adjacent equipment generates heat, keep it at least 10 cm to 15 cm away from the power supply.
- Make sure the power supply is properly grounded before use.

- When using the power supply, do not exceed the upper limit of its output current and output power. Refer to the power supply's nameplate for specific parameters.
- Non-standard installations or using the power supply in high-temperature environments will increase the temperature of the internal components, potentially reducing output power.
- The power supply contains high-voltage circuits that pose a risk. If any abnormalities occur, disconnect the power first and have it inspected by a technician with professional electrical qualifications. Do not attempt to open the casing yourself.
- Avoid touching the power supply terminals within 5 minutes after the power has been cut off to prevent the risk of electric shock.

5.2 Heat Dissipation

The device contains photosensitive components. If the device's temperature rises, it will have a certain impact on the quality of the acquired image. Based on the above situation, this section will introduce the temperature parameters and installation suggestions to achieve better heat dissipation effect and improve the image quality and reliability of the device.

5.2.1 Temperature Parameter

Working Temperature

The temperature of the key components of industrial cameras is a key factor affecting image quality, operation stability and long-term reliability. The upper limit of the working environment temperature in the specification of the industrial camera refers to the maximum ambient temperature that the device can meet without any additional heat dissipation measures. Running within the working temperature can meet the temperature requirements on the electronic components and ensure the reliable operation of the device.

The monitoring point of the working environment temperature of the device is 80 mm away from the main housing of the device, as shown below. In the space where the device and the temperature measuring point are located, there is no object in the middle and the temperature distribution is uniform. If the on-site installation environment can add some heat dissipation measures, the temperature of electronic components can be reduced, and the image quality and reliability of the device can be further improved.

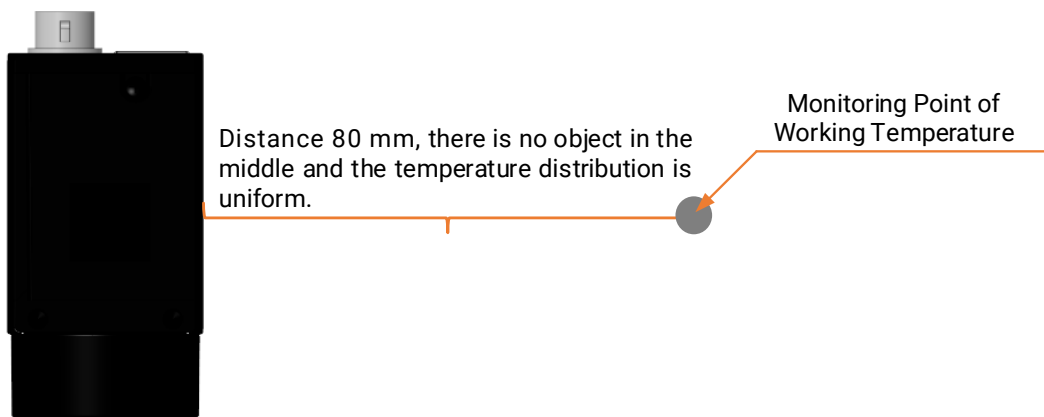

Figure 5-1 Monitoring Point of Working Temperature

Housing Temperature

After the heat generated by the electronic components is conducted to the device's housing, if the device does not have any additional heat dissipation measures, the heat is dissipated to the external environment in the form of convection and radiation through the device's housing.

The temperature of the device's housing will gradually rise during the heat dissipation process, and when the thermal equilibrium state is finally reached, the temperature tends to be stable. Therefore, we often feel that the device's housing has a certain temperature, or feel hot, which is a normal phenomenon of device heat dissipation.

Some components inside the device have done heat conduction measures to guide the heat to the housing to ensure that the temperature of the components meets the specification requirements, which also leads to a higher local temperature of the housing. Device's housing temperature is affected by power consumption, housing size, ambient temperature, and additional heat dissipation measures. Without additional heat dissipation measures, the temperature of the housing is the highest at this time. If some additional heat dissipation measures are added during field installation, the heat is dissipated to the external environment in the form of convection and radiation through the device's housing.

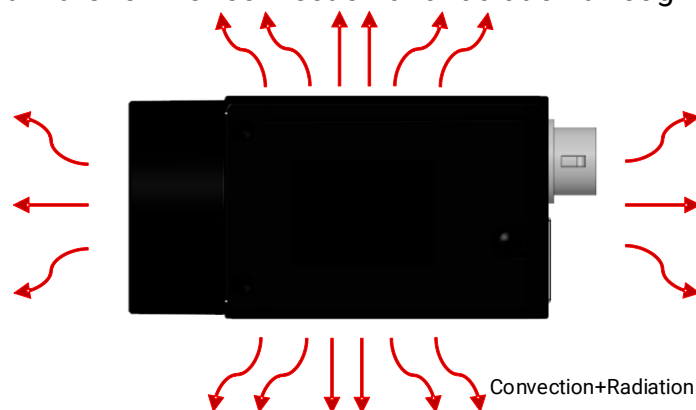

Figure 5-2 Housing Temperature

5.2.2 Heat Dissipation Measures

Heat Dissipation via Installation Part

Since most industrial cameras are fixed by the installation part, most of the heat can be guided to the metal mounting platform through the installation part during field installation, so as to dissipate the heat and greatly improve the heat dissipation efficiency of the device.

The heat discharged through the installation part depends on the heat conduction of the installation part itself and the installation method.

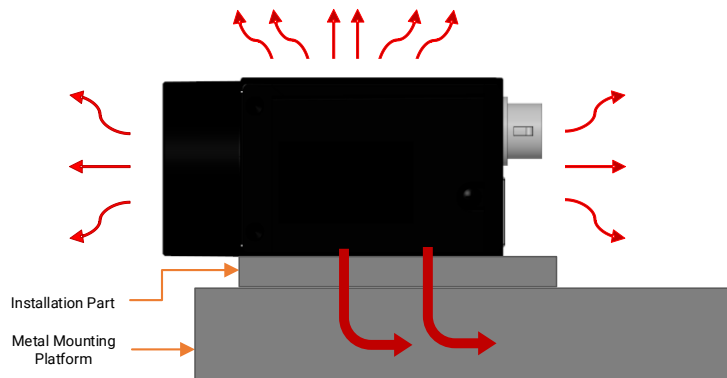

Figure 5-3 Heat Dissipation via Installation Part

- **Installation Part Material**

- Use materials with high heat conduction, such as aluminum and copper, which can quickly transfer heat away.
- At the same time, it is best to fix the installation part on the mounting platform of metal material to conduct heat to the metal parts and dissipate it.
- Minimize the use of materials with low heat conduction, such as plastic and rubber.

- **Heat Conduction Path**

- The heat conduction path of the installation part should be as short as possible to improve the heat conduction efficiency.
- The thickness, length, and bending of the installation part will affect the heat conduction path distance of the device.

As shown in the installation method 1 and 2 in figure below, the thickness of the installation part should be reduced as much as possible to shorten the heat conduction path from the device to the metal mounting platform via the installation part.

As shown in the installation method 3 and 4 in figure below, the extension of the length of the installation part and the use of bent metal will lead to the lengthening of the heat conduction path of the device.

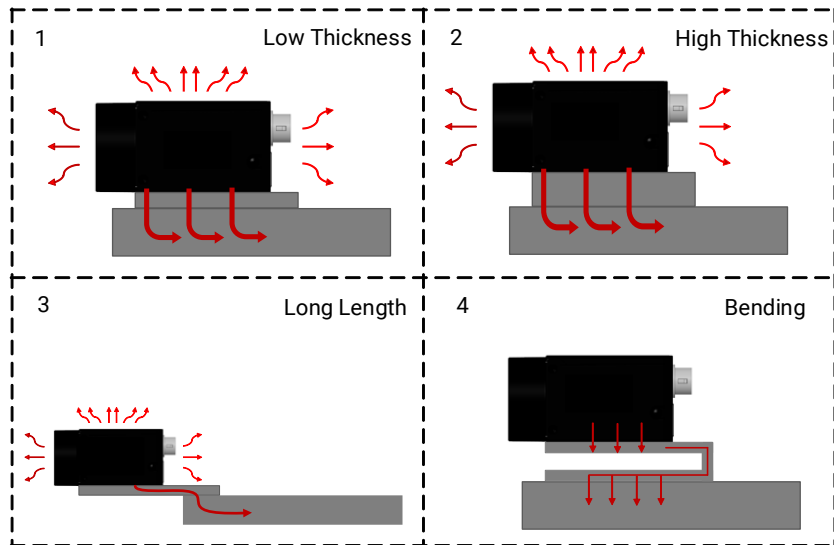

Figure 5-4 Heat Conduction Path of Different Installation Methods

- **Installation Part Section**

The cross section area along the heat conduction direction should be as large as possible, so that the heat conduction resistance can be reduced. For some installation parts have to use extended or bent metal (as shown in installation methods 3 and 4 in figure above), the thickness of the sheet metal needs to be increased as much as possible to increase the cross section of the device heat conduction path and strengthen the heat conduction.

- **Contact Area**

Surface contact should be used between the device, installation parts and the mounting platform, and the contact area between installation surfaces should be increased as much as possible to improve the heat dissipation of the device. The flatness of the installation part should be within 0.1 mm, in case the actual contact surface is not completely close, affecting the heat dissipation effect.

Heat Dissipation via Cooling Fan

For cases where the installation parts are made of plastic and other materials with poor heat conduction, ventilation equipment such as cooling fans and air conditioners can be used to increase the air flow on the surface of the device and reduce the air temperature around the device, thereby enhancing the convective heat dissipation of the device into the air.

5.2.3 Low Heat Conduction Material

If the mounting platform is made of materials with very poor heat conduction such as plastic and wall, heat dissipation can be improved in the following ways:

- Increase the surface area of the installation part.

If the installation part is in good contact with the device, it can be regarded as a part of the device's housing. The larger the heat dissipation area of the housing, the better the

heat dissipation effect. Therefore, the larger the surface area of the installation part, the better the heat dissipation effect.

- The installation part can be made into a metal heat dissipation tooth shape, or a large area flat plate to improve the heat dissipation effect.

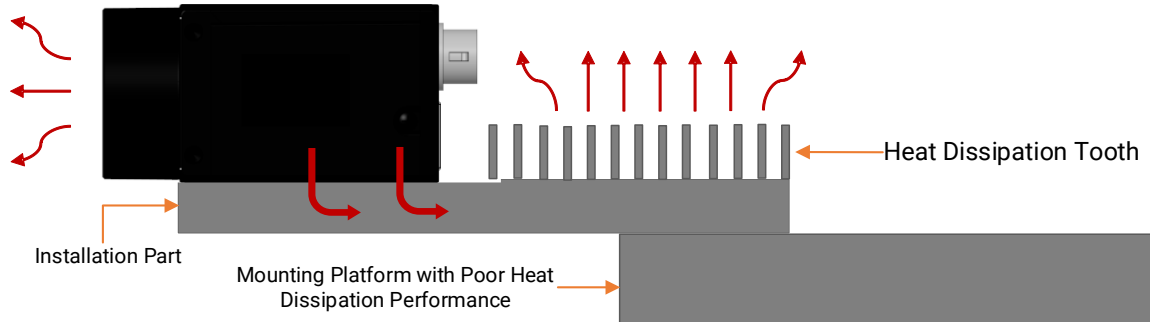

Figure 5-5 Add Heat Dissipation Tooth

- The surface of the installation part should be in contact with air as much as possible, not with a mounting platform with poor heat conduction.
- While increasing the heat dissipation area of the installation part, painting and oxidation can be used to increase the radiation heat exchange of the installation part to the external environment and strengthen the heat dissipation of the device.

Chapter 6 Accessories

6.1 Lens

6.1.1 Lens Mount

The device supports standard C-mount lenses. The thread depth of C-mount lens is not less than 7 mm.

6.1.2 Lens Selection

In order to meet the image acquisition needs of industrial cameras, our company provides a variety of lenses with high performance, high definition, low distortion rate, and other features. You should consider following factors when selecting a lens:

- Lens mount: The device supports standard C-mount lenses. When selecting lens, select lens with the same mount. When the mount of the device and the lens are different, part of the lens mounts may be switched using corresponding lens adapter.
- Flange back length: The flange back length of different lenses is varied. It is necessary to select the lens with the matched flange back length.
- Sensor size: Make sure that the target surface of the lens is larger than or equal to the size of the device's sensor.
- Resolution: It represents the ability of the lens to record the details of an object. It is generally measured in the number of line pairs that can be distinguished per millimeter: line pairs/millimeter (lp/mm). The higher the resolution of the lens, the clearer the image. Make sure that the accuracy required by the system is less than the resolution of the lens when selecting the lens.
- Working distance: It refers to the distance from the first working surface of the lens to the measured object. Make sure that the working distance is greater than the minimum object distance of the lens when selecting a lens.
- Focal length: The distance from the center point of the lens to the clear image formed on the focal plane. The smaller the focal length value is, the larger the field of view of the image captured by the digital camera is. According to the focal length of the lens, the appropriate working distance can be set up, or the appropriate lens can be selected according to the requirements of the working distance.

Note

In order to better provide a suitable lens model, you can go to the official website of our company (<https://en.hikrobotics.com/>): **Products** → **Lens** → **Lens Selector** to enter your application parameters, and you will find a suitable lens model. If you have any

problems, please contact our technical support.

6.2 Lens Cap

The device with PRO version supports many types of the lens cap. You should refer to section [Device with PRO Version](#) to install the lens cap and the lens properly for IP67 rating. The lens cap is applicable to the C-mount lens, compatible with resolutions up to 20 MP, and achieves quick installation and replacement.



Figure 6-1 Lens Cap

6.3 Cable

6.3.1 Cable Selection

According to the cable performance, it can be divided into standard, flexible, high flexible, and super flexible cables. You need to select cables according to different scenarios.

- Standard cable: It is applicable to static scenario only.
- Flexible cable: It can withstand 100,000 times of drag chain or bending movement.
- High flexible cable: It can withstand 5 million times of drag chain movement.
- Super flexible cable: It can withstand 10 million times of drag chain movement, 3 million times of bending movement or 5 million times of twisting movement.

According to the cable waterproof function, you can select waterproof cable or non-waterproof cable. The device with BASE version can be equipped with a non-waterproof cable, and for the device with PRO version, if the waterproof function is required, you must select a waterproof cable.

6.3.2 Wiring Principle

Regarding the power and I/O cable and network cable, attention should be paid to the application requirements of scenarios such as high-frequency communication and high-frequency motion. In such scenarios, if the cables are arranged in an inappropriate manner, various problems may be caused in use, such as cable skin wear, internal conductor breakage, and device packet loss. Based on the above situation, this section introduces the basic wiring principles and precautions of sports cables to help you install and use related products correctly and improve the overall healthy operating life of the system.

- The minimum bending radius of the chain rail during wiring should be controlled at more than 10 to 12 times the wire diameter (the larger the bending radius, the longer the cable movement life).
- Make sure that the cable does not spin in the chain rail, and the cable should be spread horizontally along the chain rail.
- If the cable is laid too tightly, the cable sheath and the chain rail will produce friction during the movement, which will cause the sheath to wear. Therefore, in the wiring process, the laying tension on the cable should be avoided.
- If the cable is fixed at the moving part of the chain rail, stress concentration will occur at the fixed position during the movement. Therefore, both ends of the cable can be fixed, but not at the middle moving section.
- Multiple cables may interfere with each other when moving in the chain rail. At this time, the chain rail with sufficient width should be selected to ensure that there is still a certain space after the cables are laid horizontally. The use of spacers is also an effective way to avoid interference. Note that there should also be at least 2 mm clearance between the spacer and the cable. Do not drain cables without spacers.
- Please keep the space factor occupied by the cable after laying within 30%, as shown below.

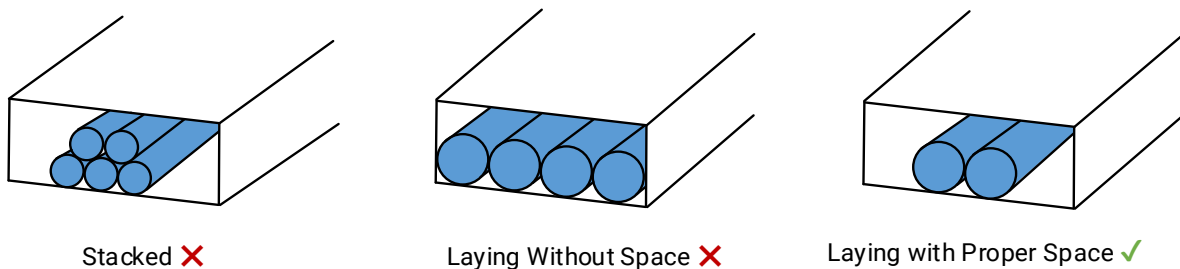

Figure 6-2 Cable Laying

- In the same chain rail, if there are cables with different thicknesses and diameters, the cables with small outer diameter are easily squeezed to the bottom by the cables with large outer diameter. In this case, use spacers for classification and isolation, as shown below.

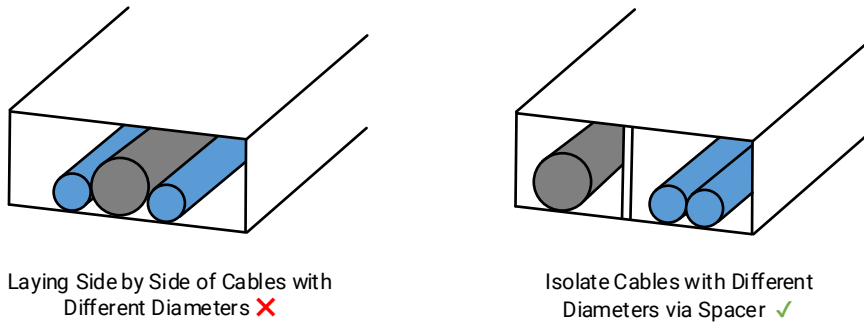

Figure 6-3 Isolated via Spacer

- If the wiring is in the same track as the hard object such as the air pipe, use a spacer to isolate it.
- If the chain rail is damaged, replace the chain rail and cable at the same time, because the damaged chain rail may aggravate the damage to the cable.
- Do not bend the cable vertically on the fixed point.

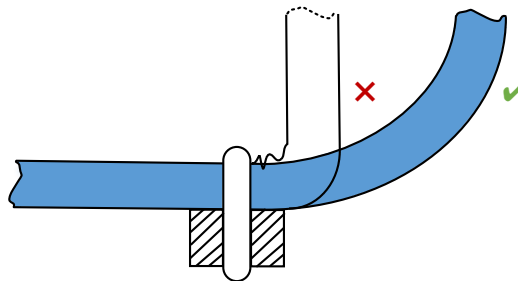

Figure 6-4 Vertically Bended Prohibited

- Make sure to reserve a suitable bending length for the cable.

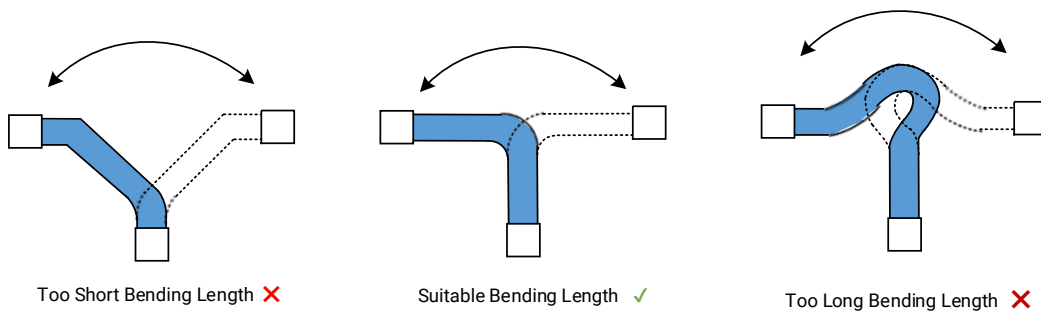

Figure 6-5 Suitable Bending Length

- Please keep a sufficient bending radius.

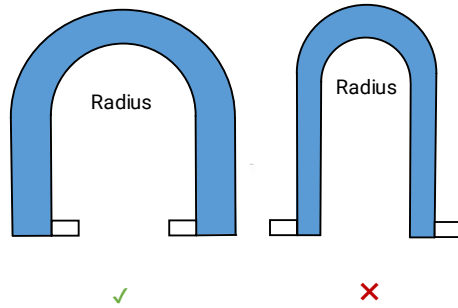

Figure 6-6 Sufficient Bending Radius

- When assembling the connector, please fix it on the connector net tail instead of the cable body.

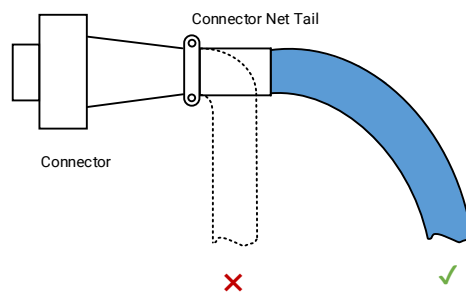

Figure 6-7 Assemble Connector

- Do not bind cables of different diameters together.

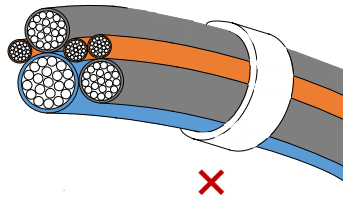

Figure 6-8 Improper Binding

Chapter 7 Quick Start Guide

The overall workflow of using the device is shown below:

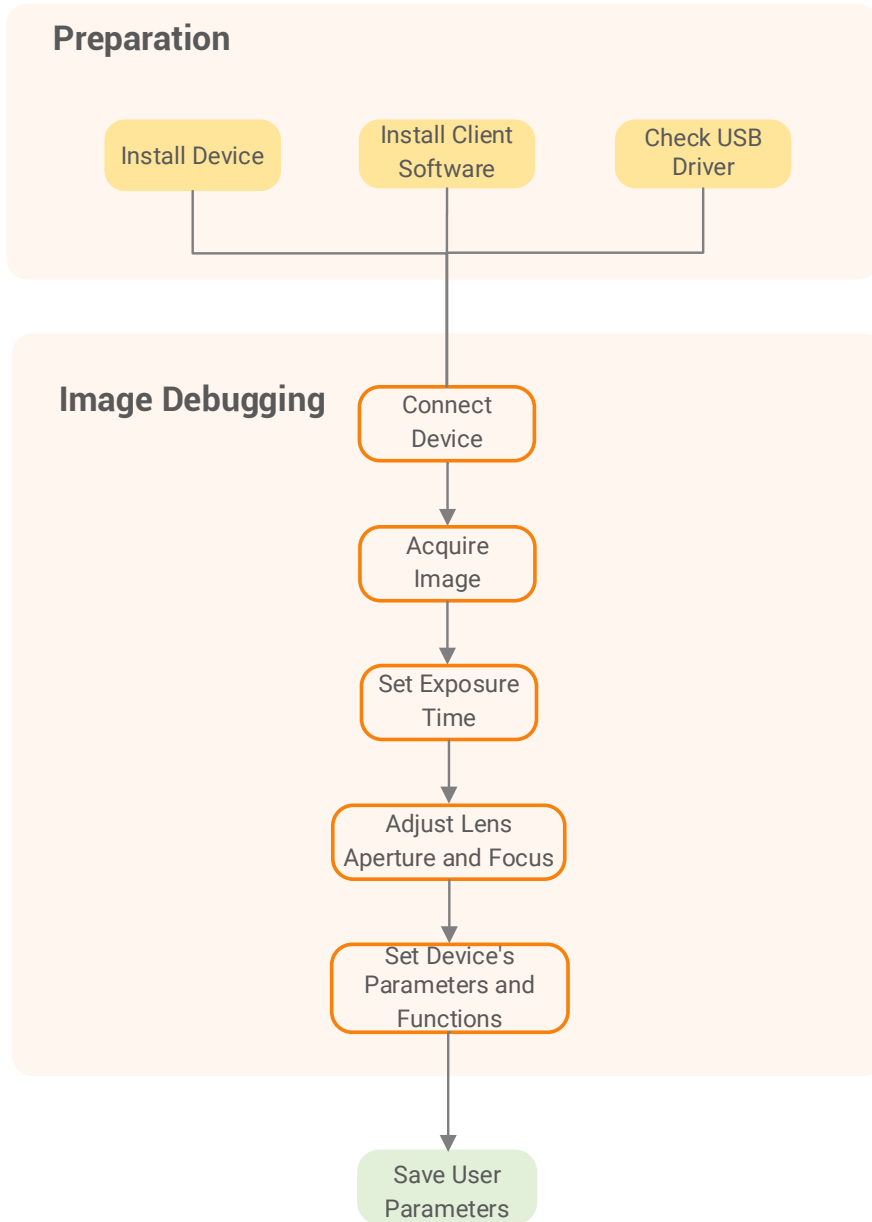

Figure 7-1 Workflow

7.1 Device Installation

7.1.1 Installation Preparation

You need to prepare following accessories before device installation.

Table 7-1 Accessories

No.	Name	Quantity	Description
1	Power and I/O Cable	1	It refers to the 8-pin M8 A-Code power and I/O cable. You need to purchase separately. Note <ul style="list-style-type: none"> Refer to device's specification for details of I/O connector. The device with PRO version needs a waterproof cable.
2	DC Power Supply	1	You should select a suitable power adapter or switch power supply according to the device power supply and consumption. You need to purchase separately.
3	Type-C Cable	1	It refers to the USB 3.0 Standard-A to Type-C cable. You need to purchase separately.
4	Lens	1	It refers to the lens that is suitable for the device. You need to purchase separately.
5	Lens Adapter	1	If the lens you used does not match with lens mount of the device, you should use a lens adapter. You need to purchase separately.
6	Protective Cap	2	They refer to the protective caps of power and I/O connector for the device with PRO version, used to protect the connector from water and dust when there is no cable connected, ensuring the IP67 rating of the device.
7	Lens Cap	1	For the device with PRO version, it refers to a lens cap. You need to purchase separately.

Note

- The device mentioned in this manual is an electronic product that requires operation and storage under dry conditions. In case of hot and humid, acidic and alkaline environment, please take isolation and protection measures to avoid corrosion damage of the device's internal components.
- When using the lens, it is necessary to prevent humid environment and avoid steam

from entering inside, causing fogging.

7.1.2 Install Device

The topology diagram may differ by device models.

Note

- The topology diagram is for reference only.
 - If there is no available USB 3.0 interface on the industrial PC, you can connect the device to the PC via a USB expansion card.
-

Device with BASE Version

The topology diagram of the device with BASE version is shown below.

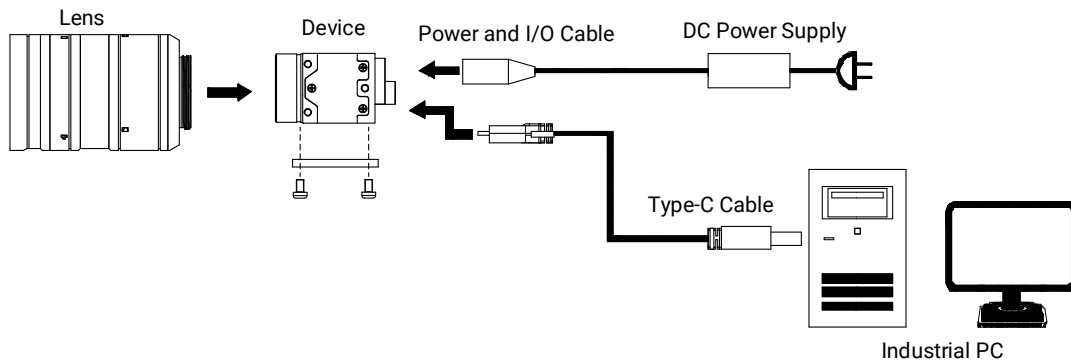

Figure 7-2 Topology Diagram of Device with BASE Version

Before You Start

- Make sure that the device in package is in good condition and all assembly parts are included.
- Make sure that all related devices are powered off during the installation.

Steps

1. Fix the device to the installation position, select an appropriate lens, and install the lens on the device.
-

Note

During device installation, heat dissipation measures of installation parts can be taken to improve the efficiency of heat dissipation. Refer to section **Heat Dissipation Measures** in the device manual for details.

2. Use the USB 3.0 Standard-A to Type-C cable to connect the device to the industrial PC or other devices.
 3. Use one of the following methods for power supply.
 - Direct plug-in power supply: Use the 8-pin M8 A-Code power and I/O cable to connect
-

device to a proper power adapter. Refer to section [Power and I/O Connector](#) for details.

- USB power supply: Use the USB 3.0 Standard-A to Type-C cable to connect the device to the PC or other devices via USB 3.0 interface.

Device with PRO Version

The topology diagram of the device with PRO version is shown below.

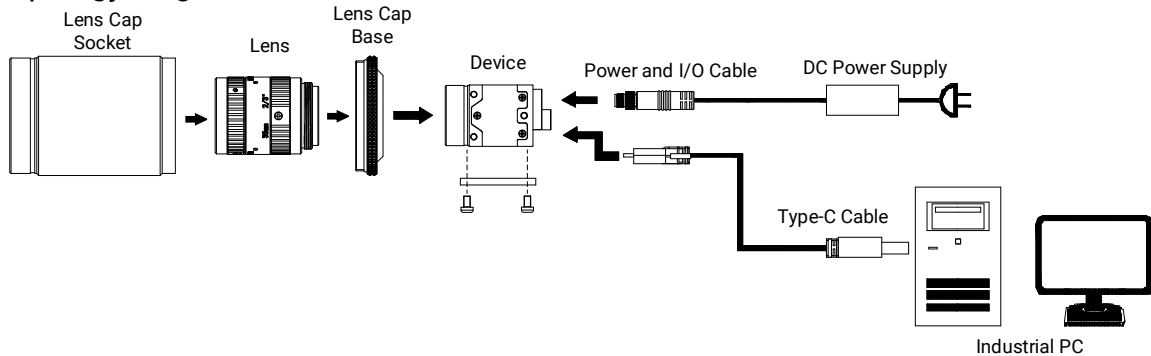

Figure 7-3 Topology Diagram of Device with PRO Version

Before You Start

- Make sure that the device in package is in good condition and all assembly parts are included.
- Make sure that all related devices are powered off during the installation.

Steps

1. Fix the device to the installation position.

Note

During device installation, heat dissipation measures of installation parts can be taken to improve the efficiency of heat dissipation. Refer to section **Heat Dissipation Measures** in the device manual for details.

2. The device supports IP67 rating. If you need to maintain IP67 rating of the lens, follow the steps below to install a lens and a lens cap.
 - a) Install the lens cap base: Screw the lens cap base with the seal into the threads on the front cover of the device, and tighten it until the base surface and the front surface are fit together.
 - b) Install the lens: Select an appropriate lens and screw it into the lens threads on the front of the camera.
 - c) Install the lens cap socket: Screw the lens cap socket into the threads on the lens cap base, and tighten it until the base surface and the socket surface are fit together.
 - d) Check the seal: Ensure all components are tightened properly, with no foreign objects or distortions on the contact surfaces.

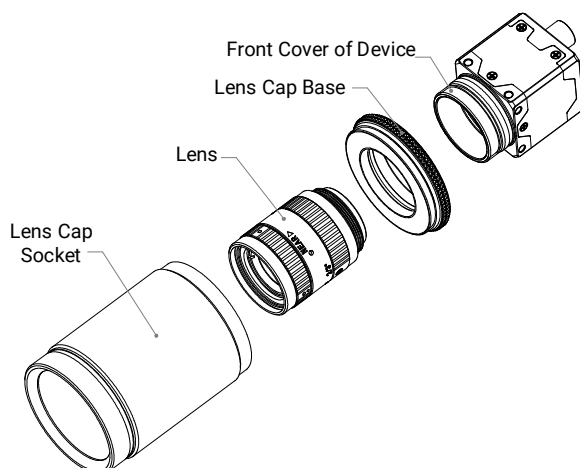

Figure 7-4 Install Lens and Lens Cap

3. Use the USB 3.0 Standard-A to Type-C cable to connect the device to the industrial PC or other devices.

Note

When installing the cable, please tighten the connection between the cable and the device interface to ensure IP67 rating and prevent water and dust.

4. Use one of the following methods for power supply.

- Direct plug-in power supply: Use the 8-pin M8 A-Code power and I/O cable to connect device to a proper power adapter. Refer to section [Power and I/O Connector](#) for details.
 - USB power supply: Use the USB 3.0 Standard-A to Type-C cable to connect the device to the PC or other devices via USB 3.0 interface.
-

Note

- When using direct plug-in power supply, please tighten the connection between the cable and the device interface to ensure IP67 rating and prevent water and dust.
 - When using USB power supply, please ensure that the lens cap of power and I/O connector is undamaged to prevent water and dust.
-

7.2 Install Client Software

MVS client software is used to connect and set device's parameters, and acquire images.

Note

- The MVS client software is compatible with 32/64-bit Windows 7/10, 64-bit Windows 11, and 32/64-bit Linux operating systems. Here we take Windows as an example.
 - The graphic user interface may differ by different versions of the client software you use.
 - The client software has integrated driver required by hardware, and no need to download and install other drivers.
-

- You can download the client software from en.hikrobotics.com.
-

Steps

1. Double click the MVS installation package.
2. Select the language.
3. Read and check **Terms of the License Agreement**.

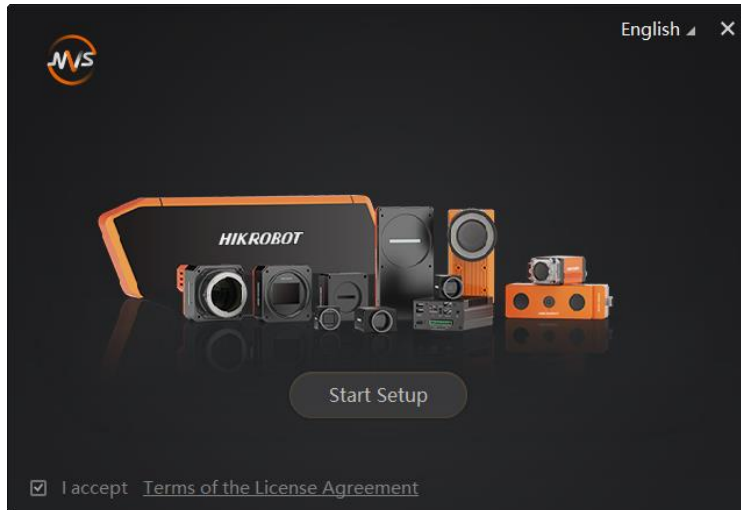

Figure 7-5 Installation Interface

4. Click **Start Setup**.
5. Select installation directory, driver and others.
 - **Select Driver:** You can check **GIGE**, **USB 3.0** and **PCIE** according to actual demands.
 - **Others:** Check **Enable built-in debug features** to make it easier to use breakpoints while the device is connected and streaming images. Check **Enable Jumbo Frame for All NICs** to enhance network transmission performance. Check **PCIE-CML**, **PCIE-CXP**, **PCIE-GEV**, **PCIE-XoF** to enumerate the corresponding frame grabbers.

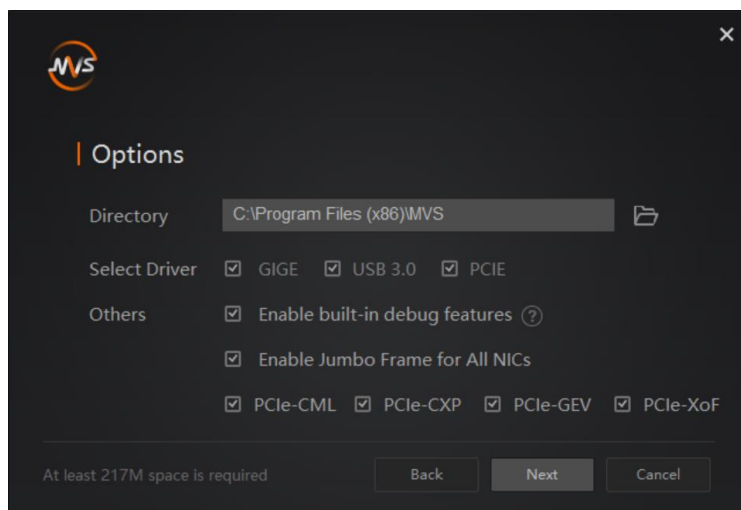

Figure 7-6 Installation Options

Note

- Regarding options, it is recommended to keep default settings.
 - **PCIe-CML, PCIe-CXP, PCIe-GEV, PCIe-XoF** can be checked only when **PCIe** is selected.
 - **PCIe-CML, PCIe-CXP, PCIe-GEV, PCIe-XoF** supports frame grabbers developed by our company only.
-

6. Click **Next** to install.
7. Finish the installation process according to the prompts.

7.3 Check Driver

Note

Before using the device, you need to make sure that the PC has installed the USB driver correctly. Otherwise, the client software cannot find the device.

After the device is connected, the PC will automatically check and install the USB driver. After installation, you can view the added driver in the device manager of the PC, and right click **Properties** to view its properties.

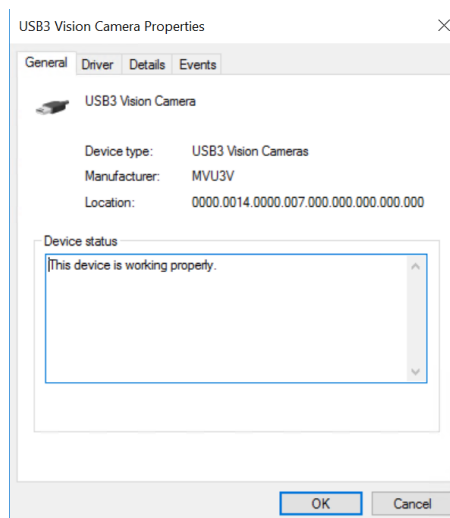

Figure 7-7 Driver Properties

If the installation of the driver is failed, you can use the driver installation tool to install the driver again manually. Go to **Start** → **MVS Folder** → **Tools**, click **Driver_Installation_Tool** to run it, and click **Uninstall** or **Install** of the corresponding driver to uninstall or install the driver again.

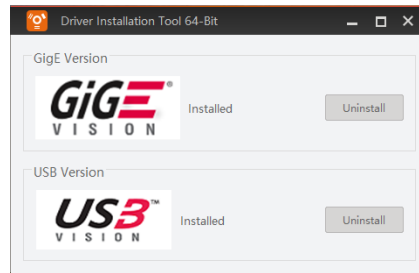

Figure 7-8 Driver Installation Tool

Note

The specific path of finding the driver installation tool may differ by Windows version and the client software version you installed.

7.4 Basic Operation

Steps

Note

Refer to the user manual of the device and client software for detailed operations.

1. Double click the device model for connection. The client software displays the device's information, as shown below.

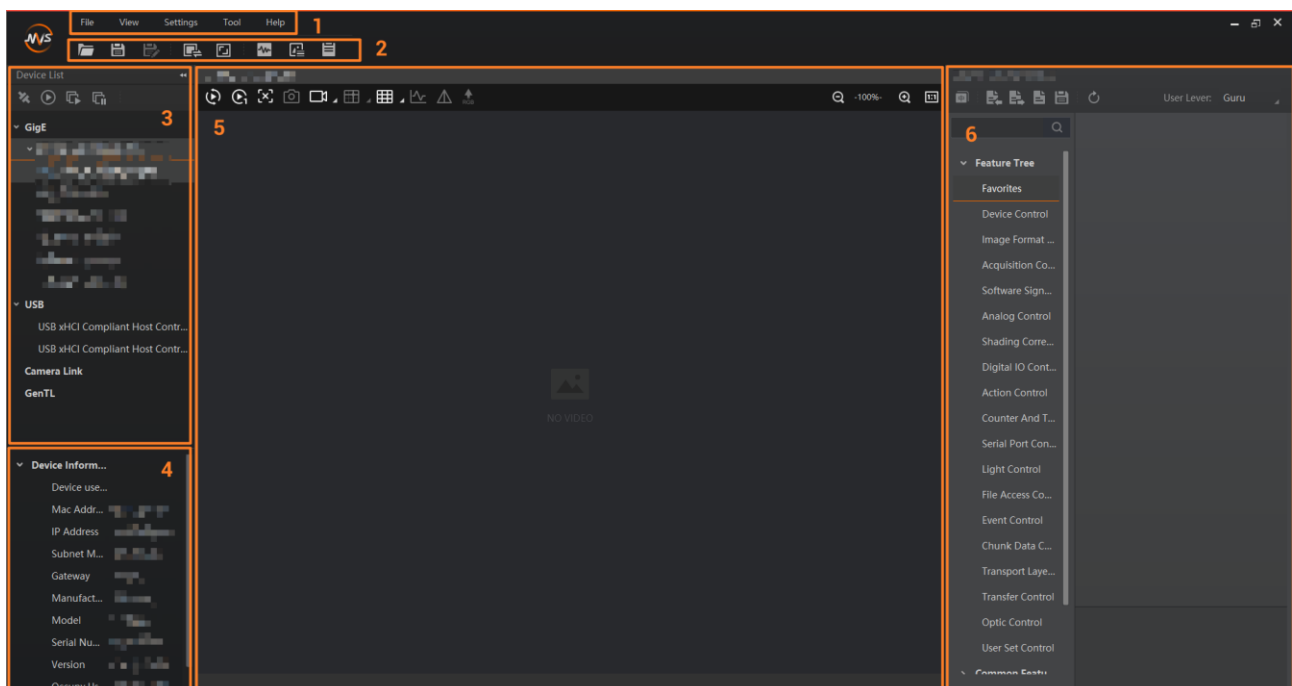



Figure 7-9 Main Window

 **Note**

For specific main window of the client software, please refer to the actual one you got.

Table 7-2 Main Window Description

No.	Name	Description
1	Menu Bar	The menu bar displays function modules, including File, View, Settings, Tool, and Help.
2	Control Toolbar	The control toolbar provides quick operations for the device, such as file function, window division, and viewing of device status, embedded information, and log.
3	Device List Panel	This panel displays the list of devices, and you can connect or disconnect device.
4	Device Information Panel	This panel displays the detailed information of connected device.
5	Display Window	This area displays the acquired images in real time.
6	Feature Panel	This panel displays the device's parameters, and you can configure them according to actual demands.

2. Set the device's pixel format, exposure time, etc., in the feature panel.
3. Click  in the display window to acquire images continuously.
4. Adjust the device's aperture and focus to have clear images.
5. (Optional) Set the device's other parameters in the feature panel.

 **Note**

The device's feature panel and parameters may differ by device models.

Chapter 8 I/O Electrical Features and Wiring

8.1 I/O Electrical Features

8.1.1 Input Signal

The internal circuit of opto-isolated input (Line 0) is as follows.

Note

- The maximum input current of Line 0 is 25 mA.
- Make sure that the input voltage is not from 1 VDC to 3.3 VDC, because the electric status between these two values are not stable.
- The breakdown voltage is 30 VDC. Keep voltage stable.

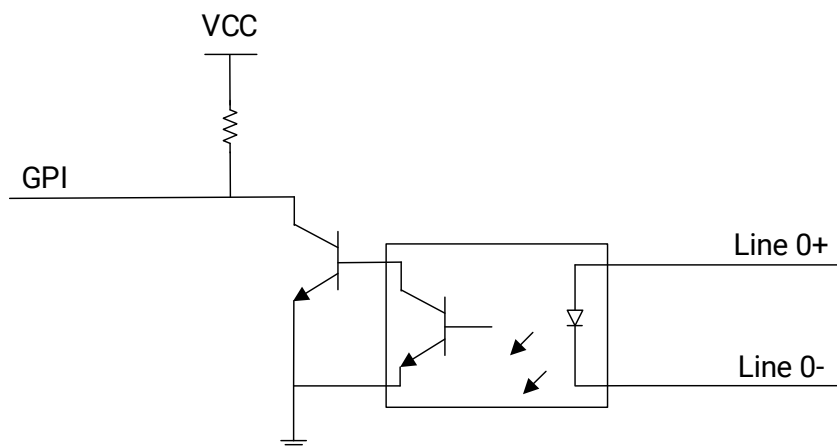

Figure 8-1 Internal Circuit of Input Signal

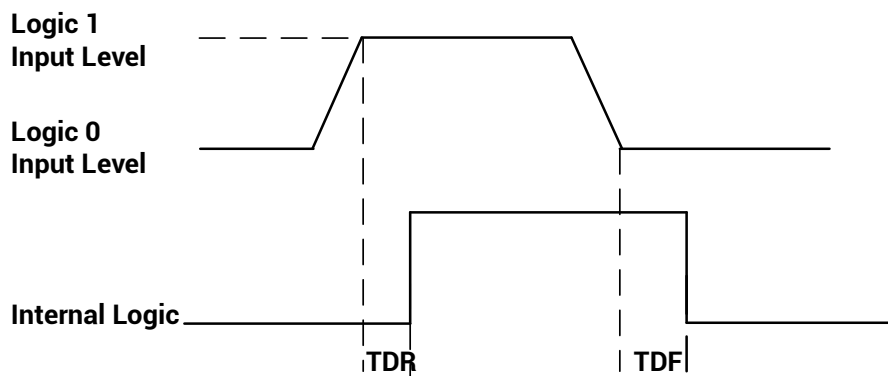

Figure 8-2 Input Logic Level

When the external voltage is 12 VDC and the external pull-up resistor is 1 K Ω , the electrical features of opto-isolated input is shown below.

Table 8-1 Input Electrical Feature

Parameter Name	Parameter Symbol	Value
Input Logic Level Low	VL	0 VDC to 1 VDC
Input Logic Level High	VH	3.3 VDC to 24 VDC
Input Rising Delay	TDR	1.28 μ s to 2.04 μ s
Input Falling Delay	TDF	25.6 μ s to 28 μ s

When the external voltage is 24 VDC and the external pull-up resistor is 4.7 K Ω , the electrical features of opto-isolated input is shown below.

Table 8-2 Input Electrical Feature

Parameter Name	Parameter Symbol	Value
Input Logic Level Low	VL	0 VDC to 1 VDC
Input Logic Level High	VH	3.3 VDC to 24 VDC
Input Rising Delay	TDR	2.32 μ s to 3.08 μ s
Input Falling Delay	TDF	22.6 μ s to 27.2 μ s

8.1.2 Output Signal

The internal circuit of opto-isolated output (Line 1) is as follows.

Note

The maximum output current of Line 1 is 25 mA.

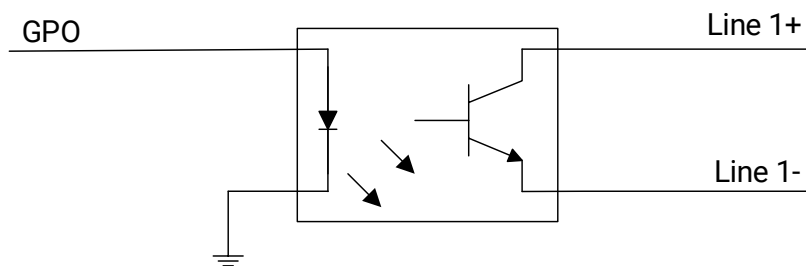

Figure 8-3 Internal Circuit of Output Signal

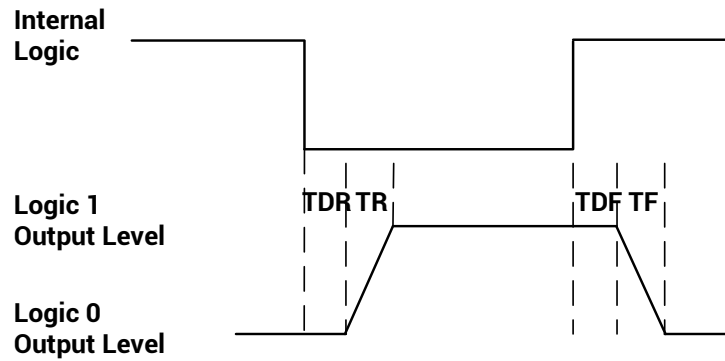

Figure 8-4 Output Logic Level

When the external voltage is 12 VDC and the external pull-up resistor is 1 KΩ, the electrical features of opto-isolated output is shown below.

Table 8-3 Output Electrical Feature

Parameter Name	Parameter Symbol	Value
Output Logic Level Low	VL	1.1 VDC to 1.46 VDC
Output Logic Level High	VH	2.54 VDC to 11.3 VDC
Output Rising Time	TR	17.6 μs to 104 μs
Output Falling Time	TF	0.4 μs to 2 μs
Output Rising Delay	TDR	26.8 μs to 72 μs
Output Falling Delay	TDF	0.44 μs to 1.92 μs

When the external voltage is 24 VDC and the external pull-up resistor is 4.7 KΩ, the electrical features of opto-isolated output is shown below.

Table 8-4 Output Electrical Feature

Parameter Name	Parameter Symbol	Value
Output Logic Level Low	VL	0 VDC to 1.3 VDC
Output Logic Level High	VH	2.26 VDC to 22.4 VDC
Output Rising Time	TR	21.6 μs to 144 μs
Output Falling Time	TF	0.4 μs to 1.6 μs
Output Rising Delay	TDR	22.4 μs to 96 μs
Output Falling Delay	TDF	0.44 μs to 1.12 μs

With different external voltage and resistance, the corresponding current and the

parameter of output logic level low are shown below.

Table 8-5 Parameters of Output Logic Level Low

External Voltage	External Resistance	VL	Output Current
3.3 VDC	1 KΩ	575 mV	2.7 mA
5 VDC	1 KΩ	840 mV	4.1 mA
12 VDC	2.4 KΩ	915 mV	4.6 mA
24 VDC	4.7 KΩ	975 mV	4.9 mA

8.1.3 Bi-Directional Signal

The device has one bi-directional non-isolated I/O signal (Line 2), and you can set it as input signal or output signal according to demands. Its internal circuit is as follows.

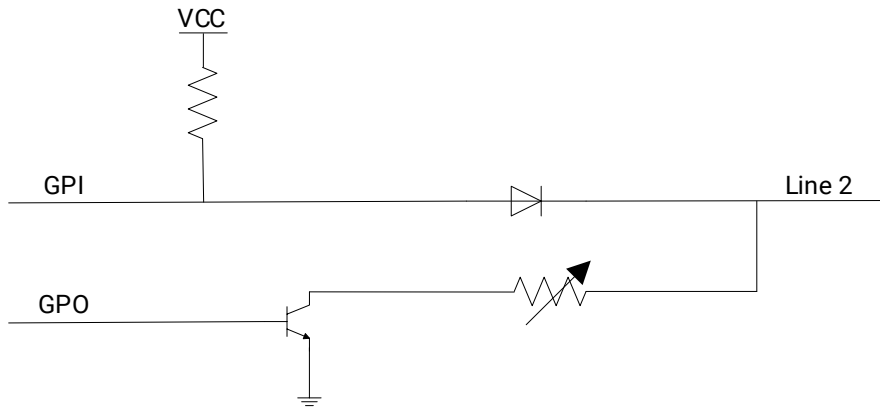

Figure 8-5 Internal Circuit of Bi-Directional Signal

Configured as Input Signal

Note

- Make sure that the input voltage is not from 1 VDC to 3.3 VDC, because the electric status between these two values are not stable.
- The breakdown voltage is 30 VDC. Keep voltage stable.
- To prevent damage to the GPIO pin, please connect GND first, and then input voltage in Line 2.

The logic level and electrical feature when Line 2 is configured as input are shown below.

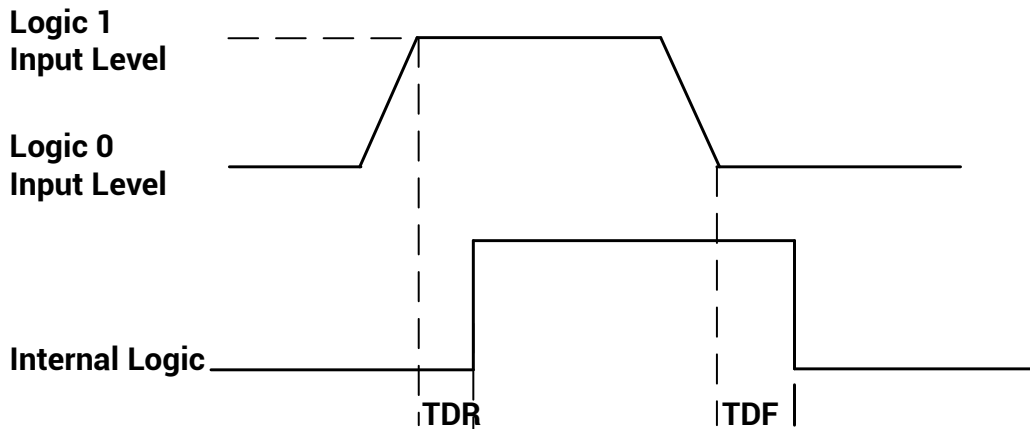

Figure 8-6 Input Logic Level

When the external voltage is 12 VDC and the external pull-up resistor is 1 K Ω , or when the external voltage is 24 VDC and the external pull-up resistor is 4.7 K Ω , the electrical features of input are shown below.

Table 8-6 Input Electrical Feature

Parameter Name	Parameter Symbol	Value
Input Logic Level Low	VL	0 VDC to 1 VDC
Input Logic Level High	VH	3.3 VDC to 24 VDC
Input Rising Delay	TDR	< 1 μ s
Input Falling Delay	TDF	< 1 μ s

Configured as Output Signal

Note

The maximum current is 25 mA and the output impedance is 40 Ω .

The relation among external voltage, resistance, and the output level low is shown below.

Table 8-7 Parameters of Output Logic Level Low

External Voltage	External Resistance	VL (GPIO2)
5 VDC	1 K Ω	0 V
12 VDC	1 K Ω	0 V
24 VDC	1 K Ω	0 V to 1 V

The logic level and electrical feature when Line 2 is configured as output are shown below.

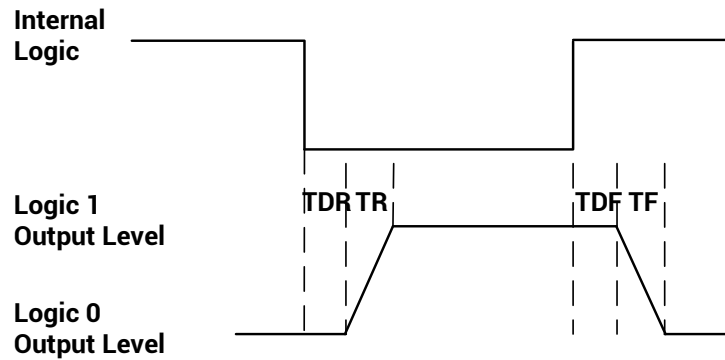

Figure 8-7 Output Logic Level

When the external voltage is 12 VDC and the external pull-up resistor is 1 KΩ, the electrical features of output is shown below.

Table 8-8 Output Electrical Feature

Parameter Name	Parameter Symbol	Value
Output Logic Level Low	VL	0 VDC
Output Logic Level High	VH	7.8 VDC to 11.8 VDC
Output Rising Time	TR	0.46 μs to 0.9 μs
Output Falling Time	TF	42 ns to 70 ns
Output Rising Delay	TDR	500 ns to 600 ns
Output Falling Delay	TDF	34 ns to 42 ns

When the external voltage is 24 VDC and the external pull-up resistor is 4.7 KΩ, the electrical features of output is shown below.

Table 8-9 Output Electrical Feature

Parameter Name	Parameter Symbol	Value
Output Logic Level Low	VL	0 VDC to 0.2 VDC
Output Logic Level High	VH	5 VDC to 23.2 VDC
Output Rising Time	TR	0.44 μs to 4.48 μs
Output Falling Time	TF	34 ns to 88 ns
Output Rising Delay	TDR	0.54 ns to 1.52 ns
Output Falling Delay	TDF	34 ns to 232 ns

8.1.4 Factors Affecting Transmission Delay of I/O Lines

The factors that affect the transmission delay of I/O lines are shown below, where ★ represents the main influencing factor and ☆ represents the secondary factor.

Table 8-10 Factors Affecting Transmission Delay of I/O Lines

Factors Lines	Working Temperature	Production Differences of Electronic Components	Aging	External I/O Power Supply Voltage	Load Resistance	Load Current
Opto-Isolated Input Lines	★	★	★	★	-	-
GPIO Input Lines	☆	☆	-	-	-	-
Opto-Isolated Output Lines	★	★	★	★	★	★
GPIO Output Lines	☆	☆	-	☆	☆	☆

Regarding the factors that affect the transmission delay of I/O lines in the table above, we provide the following explanations and suggestions:

- Use the I/O circuit at the recommended working temperature of the device. See the device's datasheet for the working temperature.
- Applying current to the input and output circuits of the opto-coupler will accelerate the aging rate of the opto-coupler. Keep the current to a minimum level, and ensure a stable transmission delay.
- In order to reduce the low-speed transmission delay, it is recommended to use an external I/O supply voltage of about 5 V.
- For a better quick trigger, use the recommended pull-up resistor.
- Generally, the trigger input-output frequency of an opto-coupler circuit rarely exceeds 10 kHz, and the trigger input-output frequency of a GPIO circuit rarely exceeds 1 MHz. Keep the trigger input-output frequency of the circuit within this range.
- If you need to reduce the transmission delay, it is recommended to use the GPIO line, which has a shorter transmission delay than the opto-coupler delay. But the GPIO line has the risk of burning out, so please use it with caution.

- The bounce of the trigger signal may cause the internal bounce of the device to increase. To avoid bounce, keep the edge of the trigger signal steep to reduce the internal bounce of the device (preferably less than 1 μ s).

8.2 I/O Wiring

This section introduces how to wire the device via its I/O connector.

Note

- Here we take the device with BASE version as an example to introduce I/O wiring.
 - The appearance here is for reference only, and the actual device you purchased shall prevail.
 - The orange arrow in the wiring diagram indicates the direction of current after wiring.
-

8.2.1 Input Signal Wiring

The input signal wiring is shown below when the device uses Line 0 as trigger source in external trigger mode.

Note

Input signal wiring may differ by the external device type.

PNP Device

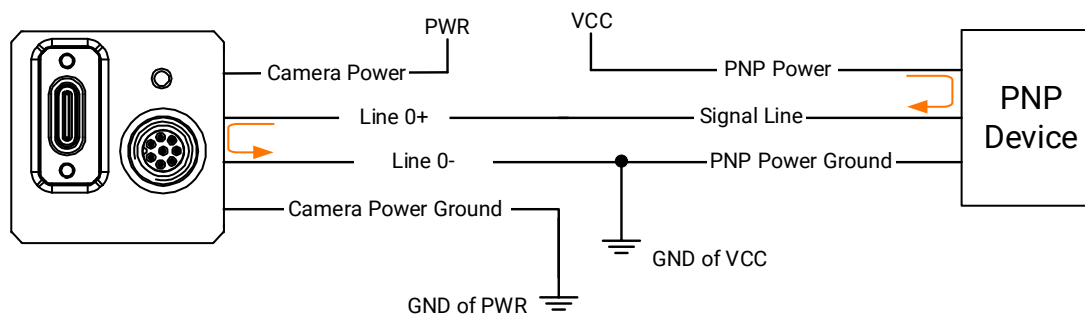

Figure 8-8 Input Signal Connects to PNP Device

NPN Device

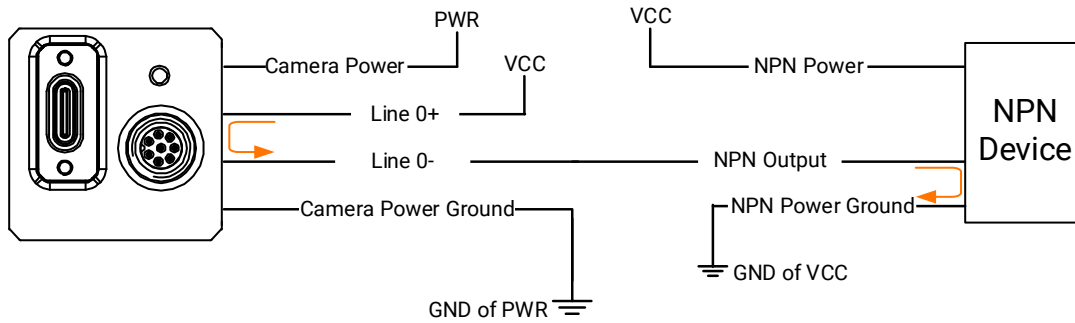

Figure 8-9 Input Signal Connects to NPN Device

Switch

If the VCC of switch is 24 VDC, it is recommended to connect a 4.7 K Ω resistor in series with the switch to protect circuit.

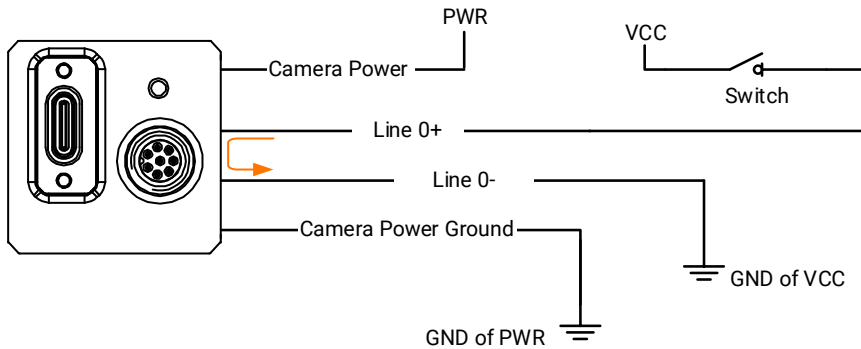

Figure 8-10 Input Signal Connects to Switch

8.2.2 Output Signal Wiring

The output signal wiring is shown below when the device uses Line 1 as the output signal.

Note

Output signal wiring may differ by the external device type.

PNP Device

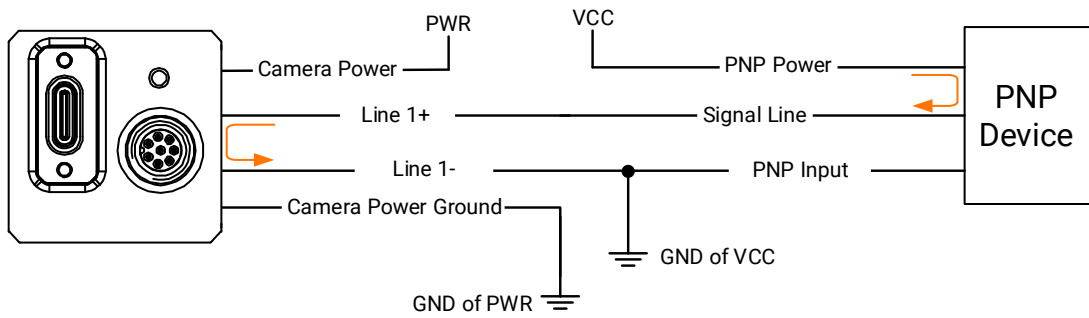

Figure 8-11 Output Signal Connects to PNP Device

NPN Device

- If the pull-up resistor is not used, the recommended wiring is shown below.

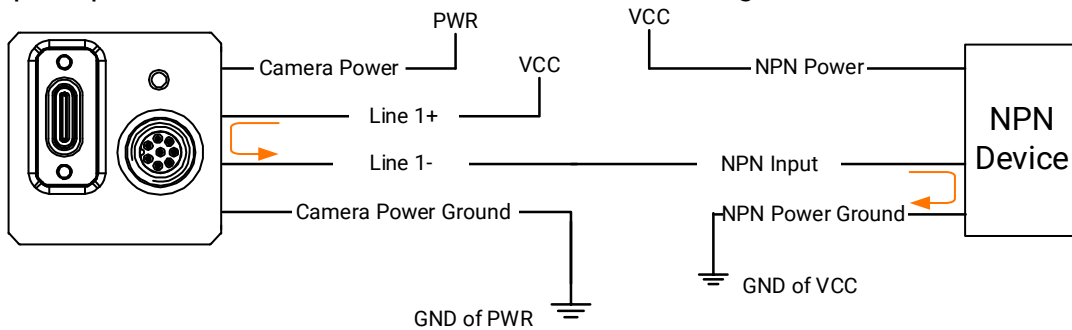

Figure 8-12 Output Signal Connects to NPN Device (Pull-Up Resistor Not Used)

- If the VCC of NPN device is 24 VDC, it is recommended to use a 4.7 K Ω pull-up resistor.
- If the VCC of NPN device is 12 VDC, it is recommended to use a 1 K Ω pull-up resistor.

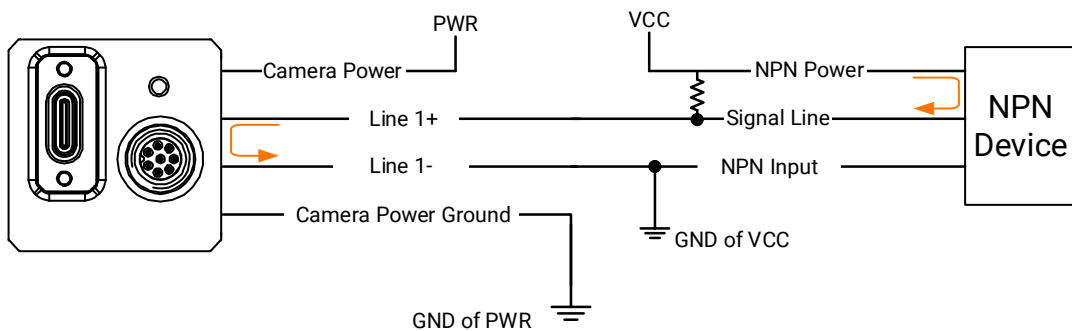

Figure 8-13 Output Signal Connects to NPN Device

8.2.3 Bi-Directional Signal Wiring

The device's Line 2 can be used as input signal and output signal.

Configured as Input Signal

The input signal wiring is shown below when the device's Line 2 is configured as the input signal.

Note

Input signal wiring may differ by the external device type.

PNP Device

It is recommended to use a 330 Ω pull-down resistor.

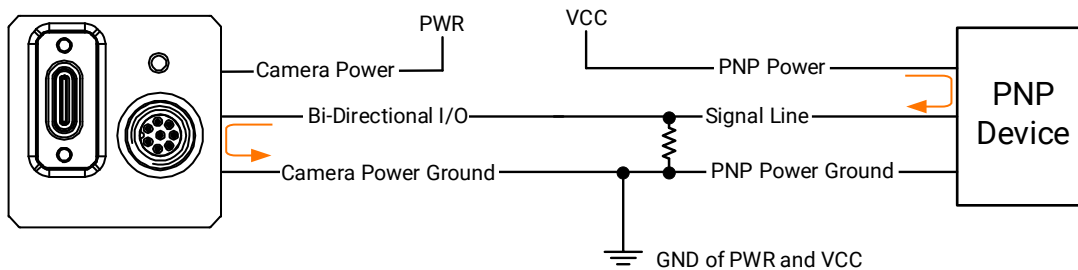

Figure 8-14 Input Signal Connects to PNP Device

Note

When connecting to PNP device, it is not recommended to use Line 2 as the input, which will cause the device to overheat severely. Line 0 as the input is recommended.

NPN Device

- If the VCC of NPN device is 24 VDC, it is recommended to use a 4.7 K Ω pull-up resistor.
- If the VCC of NPN device is 12 VDC, it is recommended to use a 1 K Ω pull-up resistor.

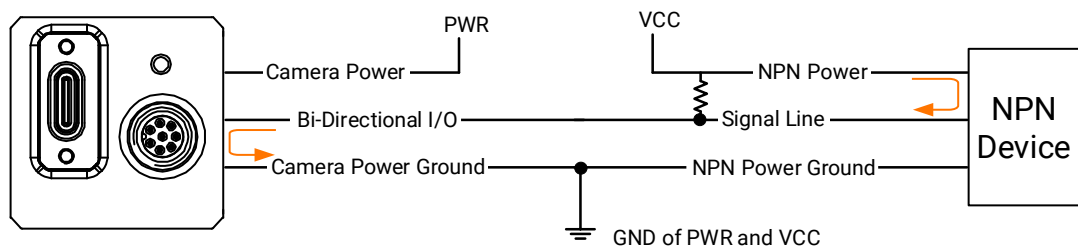

Figure 8-15 Input Signal Connects to NPN Device

Switch

The switch value can provide low electrical level to trigger Line 2.

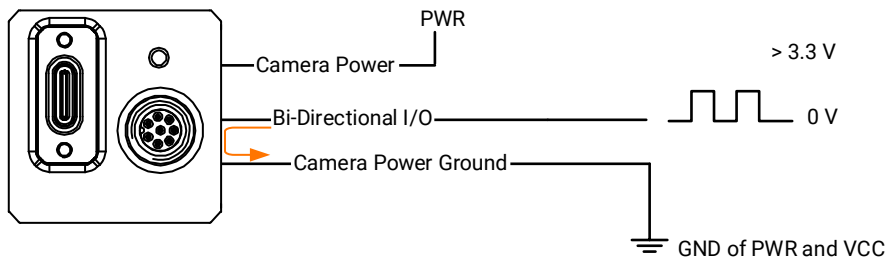

Figure 8-16 Input Signal Connects to Switch

Configured as Output Signal

The output signal wiring is shown below when the device's Line 2 is configured as the output signal.

Note

Output signal wiring may differ by the external device type.

PNP Device

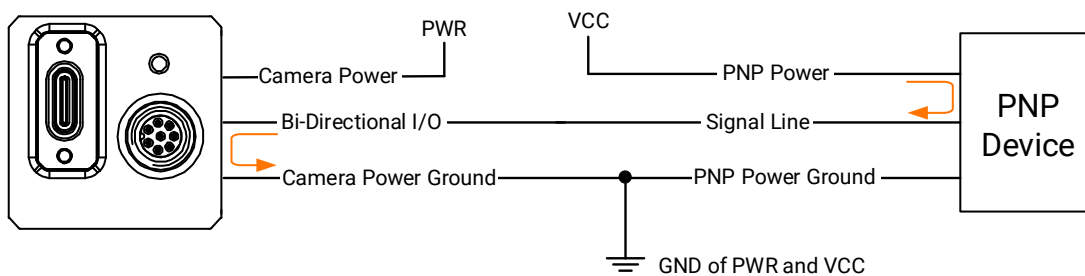

Figure 8-17 Output Signal Connects to PNP Device

NPN Device

- If the VCC of NPN device is 24 VDC, it is recommended to use a 4.7 K Ω pull-up resistor.
- If the VCC of NPN device is 12 VDC, it is recommended to use a 1 K Ω pull-up resistor.

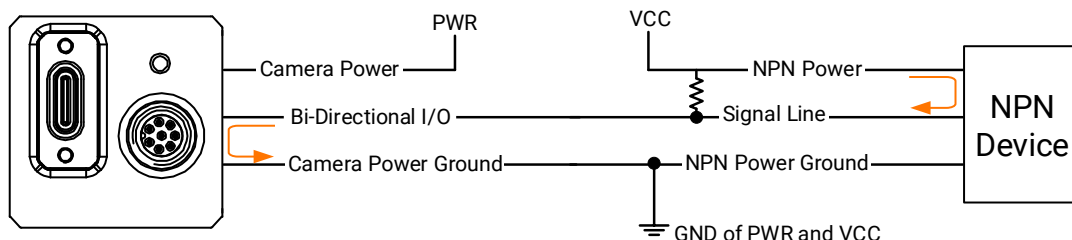

Figure 8-18 Output Signal Connects to NPN Device

Chapter 9 Trigger Input and Output

9.1 Trigger Input

9.1.1 Set Trigger Mode

The device supports 4 trigger modes, including internal trigger mode, external trigger mode, exposure start mode, and exposure end mode.

- **Internal Trigger Mode:** In this mode, the device acquires images via its internal signals.
- **External Trigger Mode:** In this mode, the device acquires images via external signals like software signal and hardware signal. The trigger source of external trigger mode includes multiple modes. Refer to section [Set Trigger Source](#) for details.
- **Exposure Start Mode:** In this mode, the device starts exposure via external signals like software signal and hardware signal. The trigger source of external trigger mode includes software trigger, hardware trigger, and counter trigger.
- **Exposure End Mode:** In this mode, the device ends exposure via external signals like software signal and hardware signal. The trigger source of external trigger mode includes software trigger, hardware trigger, and counter trigger.

Enable Internal Trigger Mode

Go to **Acquisition Control** → **Trigger Mode**, and select **Off** as **Trigger Mode**.

Note

Off refers to the internal trigger mode.

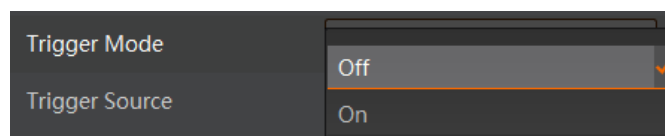

Figure 9-1 Enable Internal Trigger Mode

Enable External Trigger Mode

Go to **Acquisition Control** → **Trigger Mode**, and select **On** as **Trigger Mode**.

Note

On refers to the external trigger mode.

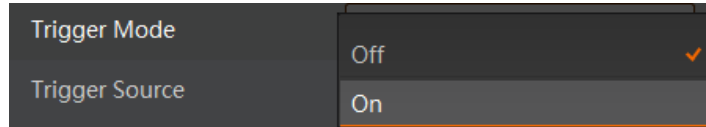

Figure 9-2 Enable External Trigger Mode

Note

If **Exposure Start** or **Exposure End** is required, you can select **On** or **Off** in **Trigger Mode**.

9.1.2 Set Trigger Source

External Trigger Source

The device's external trigger source includes software trigger, hardware trigger, counter trigger, action command trigger, and anyway mode. Go to **Acquisition Control** → **Trigger Source**, and select **Trigger Source** according to actual demands.

Table 9-1 Trigger Source Description

External Trigger Source	Parameter	Description
Software Trigger	Software Software1/2/3	The software sends trigger signal to the device via USB 3.0 to acquire images.
Hardware Trigger	Line 0 Line 2	External device connects to the device via device I/O interface. External device sends trigger signal to device to acquire images.
Counter Trigger	Counter 0	The counter sends trigger signal to the device to acquire images.
Anyway	Anyway	The device can receive software trigger, hardware trigger, or action command trigger to acquire images.

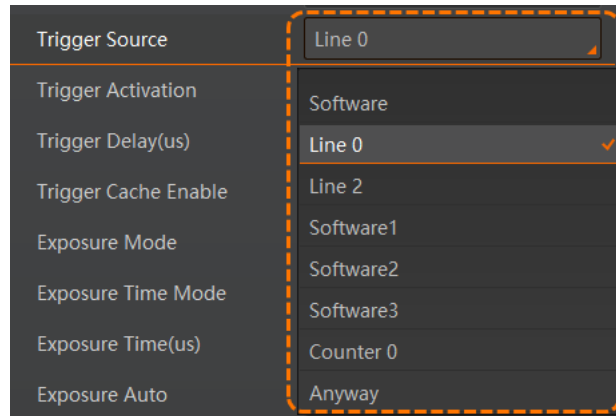

Figure 9-3 External Trigger Source

Note

These external trigger sources are valid only when the **Trigger Mode** is **On**.

Set and Execute Software Trigger

In software trigger, the software sends trigger signal to the device to acquire images.

Steps

1. Go to **Acquisition Control** → **Trigger Mode**, and select **On** as **Trigger Mode**.
2. Select **Software** or **Software1/2/3** as **Trigger Source**.
3. Click **Execute** in **Trigger Software**.

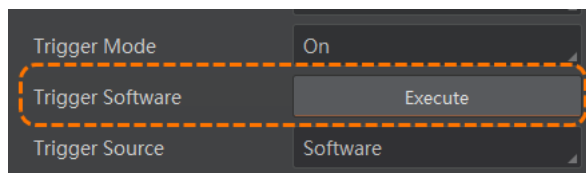

Figure 9-4 Set and Execute Software Trigger

Note

Refer to section [Set Trigger Related Parameters](#) for parameters that can be configured in the trigger source.

Set and Execute Hardware Trigger

In hardware trigger, external device sends trigger signal to the device to acquire images via I/O connector.

Steps

1. Go to **Acquisition Control** → **Trigger Mode**, and select **On** as **Trigger Mode**.
2. Select **Line 0** or **Line 2** as **Trigger Source** according to actual demands.

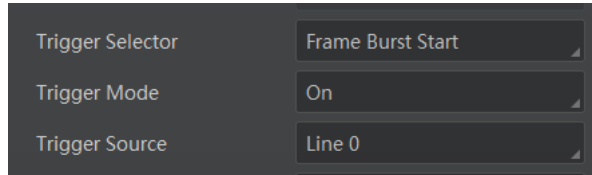

Figure 9-5 Set Line 0 or Line 2 as Input Signal

The device has one opto-isolated input (Line 0), and one bi-directional I/O (Line 2) that can be configured as input signal. Make sure that Line 2 is input signal if you want to use it as trigger source.

Steps

1. Go to **Digital IO Control** and select **Line 2** as **Line Selector**.
2. Select **Input** as **Line Mode**.

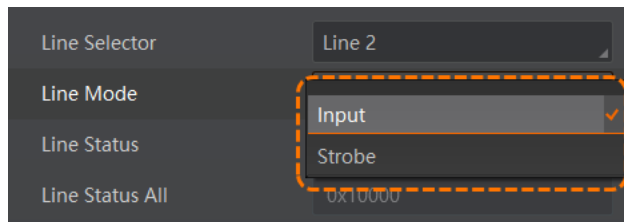

Figure 9-6 Set Line 2 as Input Signal

Note

Refer to section [Set Trigger Related Parameters](#) for parameters that can be configured in the trigger source.

Set and Execute Counter Trigger

In counter trigger, the counter sends trigger signal to the device to acquire images.

Steps

1. Go to **Acquisition Control** → **Trigger Mode**, and select **On** as **Trigger Mode**.
2. Select **Counter 0** as **Trigger Source**.

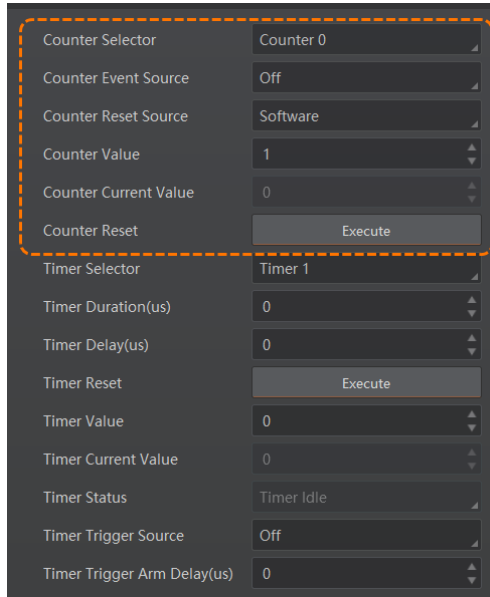

Figure 9-7 Set and Execute Counter Trigger

When using counter trigger, you need to set parameters of **Counter And Timer Control** as shown below.

Table 9-2 Parameters of Counter And Timer Control

Parameter	Read/Write	Description
Counter Selector	Read & Write	It selects counter source. Counter 0 and Counter 1 are available only at present. Note Counter 0 should be selected when counter trigger is executed. This table only introduces functions related to Counter 0 . If you want to see functions of Counter 1 , refer to section Set Counting for details.
Counter Event Source	Read & Write	It selects the signal source of counter trigger when Counter 0 is selected. Line 0 and Line 2 are available. This parameter is disabled by default.
Counter Reset Source	Read & Write	It selects the signal source of resetting counter when Counter 0 is selected. Software is available only. This parameter is disabled by default.
Counter Reset	Write is available under certain condition	It resets counter and it can be executed only when Software is selected as Counter Reset Source .

Parameter	Read/Write	Description
Counter Value	Read & Write	It is the counter value. If the parameter is set to n, the n external trigger signals can perform one counter trigger and acquire one frame of image.
Counter Current Value	Read Only	It displays the number of executed external triggers.

Note

Refer to section [Set Trigger Related Parameters](#) for parameters that can be configured in the trigger source.

Set and Execute Anyway Mode

In the anyway mode, the device can receive software trigger, hardware trigger, and action command trigger to acquire images.

Steps

1. Go to **Acquisition Control** → **Trigger Mode**, and select **On** as **Trigger Mode**.
2. Select **Anyway** as **Trigger Source**.

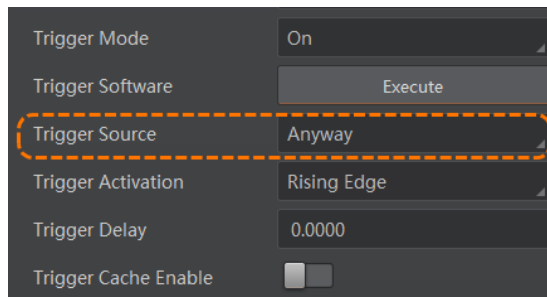

Figure 9-8 Set and Execute Anyway Mode

Note

Refer to section [Set Trigger Related Parameters](#) for parameters that can be configured in the trigger source.

9.1.3 Set Trigger Related Parameters

In external trigger mode, you can set related parameters, including acquisition burst frame count, trigger delay, trigger cache, trigger activation, trigger arm delay, and trigger

debouncer.

Note

- Different trigger sources can set various parameters in external trigger mode.
- √ is supported, and × is not supported.

Table 9-3 Trigger Source and Trigger Related Parameters

Trigger Source Trigger Parameters	Software Trigger	Hardware Trigger	Counter Trigger	Anyway Mode
Acquisition Burst Frame Count	√	√	√	√
Trigger Delay	√	√	√	√
Trigger Cache	√	√	√	√
Trigger Activation	×	√	√	√
Trigger Arm Delay	√	√	√	√
Trigger Debouncer	×	√	√	Support when triggering via hardware

Set Acquisition Burst Frame Count

In external trigger mode, you can set acquisition burst frame count. Go to **Acquisition Control** → **Acquisition Burst Frame Count**, and enter **Acquisition Burst Frame Count** according to actual demands.

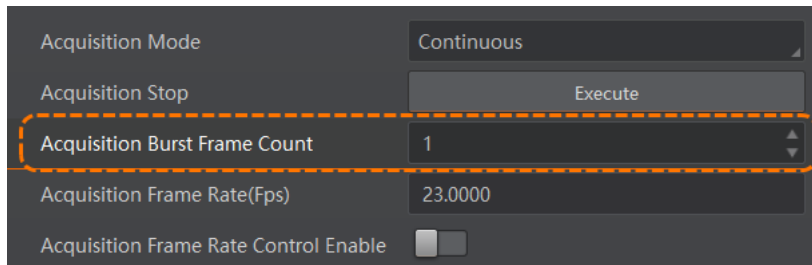

Figure 9-9 Set Acquisition Burst Frame Count

Note

- If **Acquisition Burst Frame Count** is 1, the device is in single frame trigger mode. If **Acquisition Burst Frame Count** is larger than 1, the device is in multi-frame trigger mode.
- If **Acquisition Burst Frame Count** is n, when input 1 trigger signal to the device, the device stops acquiring images after exposing n times and outputting n frame images.
- The sequence diagram below uses rising edge as trigger activation.

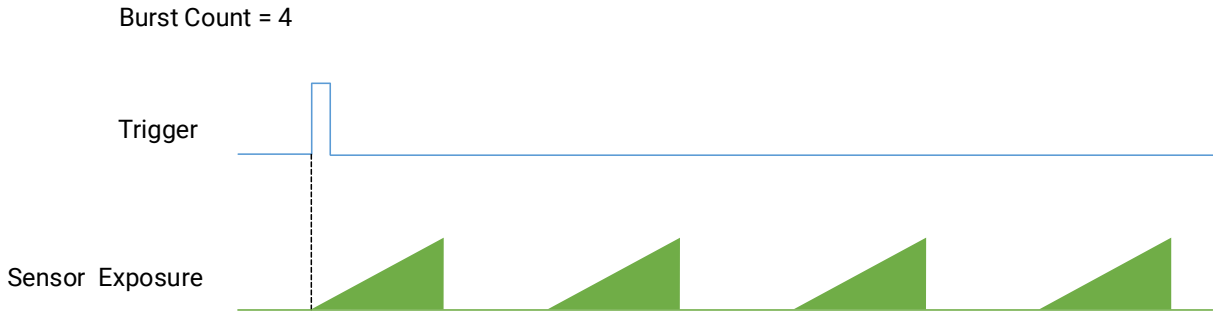

Figure 9-10 Sequence Diagram of Acquisition Burst Frame Count

Set Trigger Delay

The trigger delay function allows the device to add a delay between the receipt of trigger signal and the moment the trigger becomes active. Go to **Acquisition Control** → **Trigger Delay**, and enter **Trigger Delay**. The value should be between 0 and 16000000, and the unit is μs .

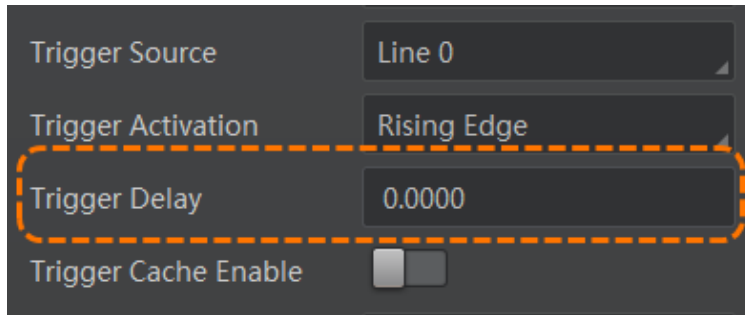

Figure 9-11 Set Trigger Delay

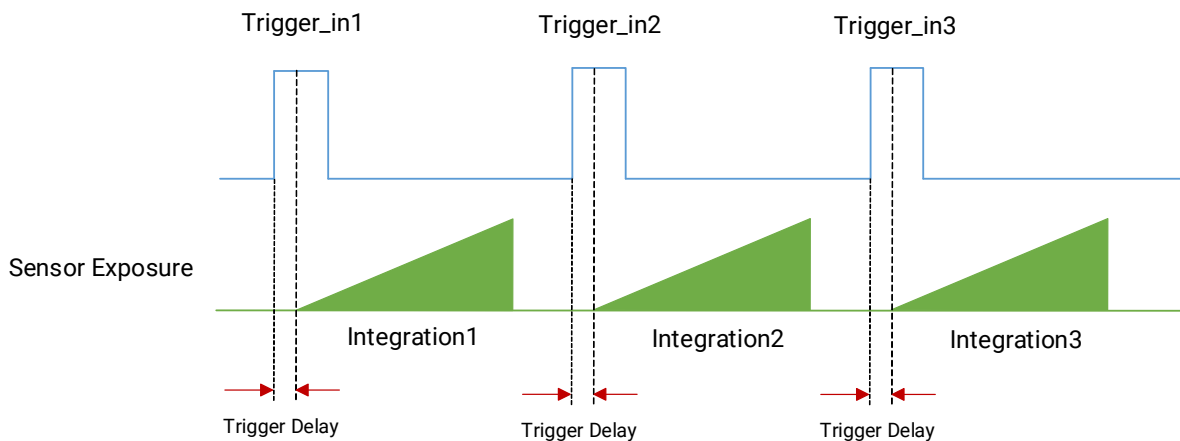

Figure 9-12 Sequence Diagram of Trigger Delay

Note

The sequence diagram above uses rising edge as trigger activation.

Set Trigger Cache

The trigger cache function allows the device to save and process new signal during trigger stage, and the device can save and process three trigger signals at most. Go to **Acquisition Control** → **Trigger Cache Enable**, and enable **Trigger Cache Enable**.

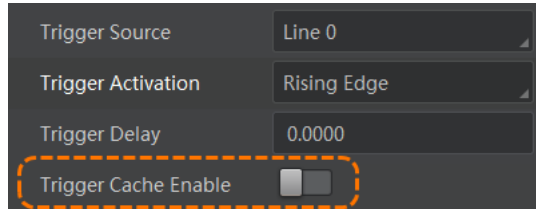

Figure 9-13 Set Trigger Cache

For example, if the device receives the 2nd trigger signal when it is processing the 1st trigger signal, and the result will be different depending on whether **Trigger Cache Enable** is enabled or not.

- The 2nd trigger signal will be filtered without processing if **Trigger Cache Enable** is disabled.

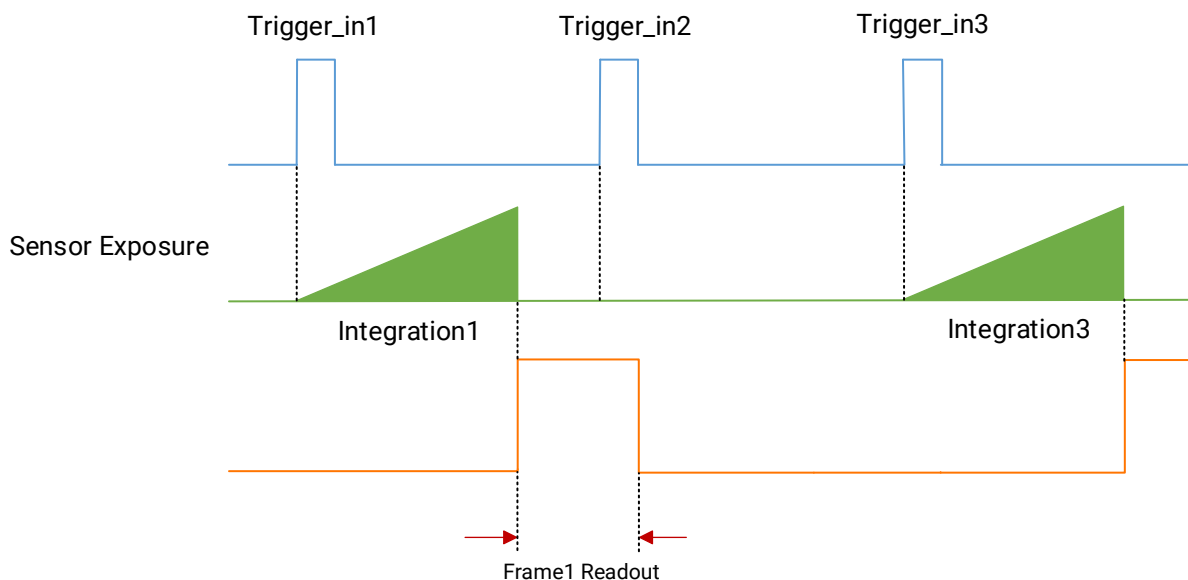

Figure 9-14 Second Frame Filtered

- The 2nd trigger signal will be saved if **Trigger Cache Enable** is enabled. If the 1st frame image's exposure time of the 2nd trigger signal is not earlier than the device's last frame creation time of the 1st trigger signal, and then the 2nd trigger signal's

1st frame image is created normally.

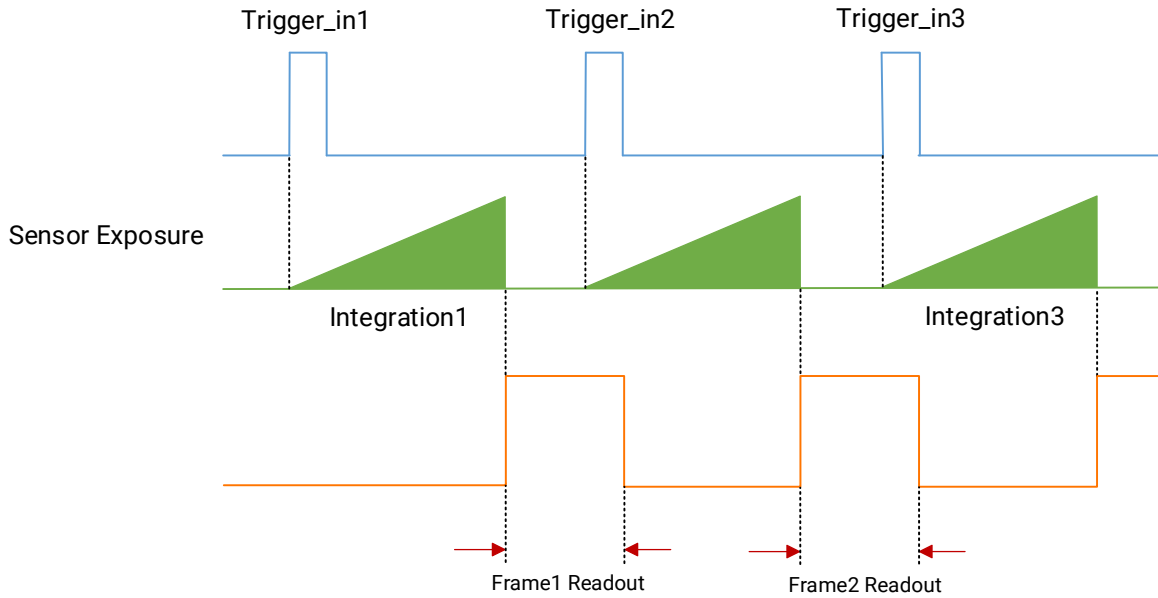

Figure 9-15 Second Frame Created Normally

If the 1st frame image's exposure time of the 2nd trigger signal is earlier than the device's last frame creation time of the 1st trigger signal, and then the device will delay this exposure time. Thus making sure this exposure time is not earlier than the device's last frame creation time of the 1st trigger signal.

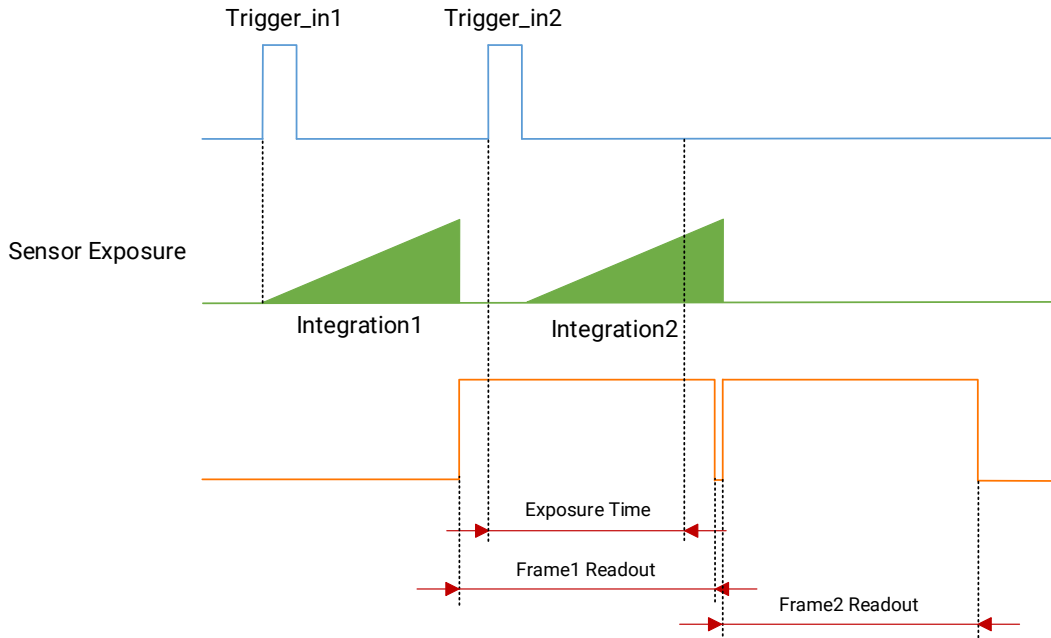

Figure 9-16 Sequence Diagram

Note

The three sequence diagrams above use rising edge as trigger activation.

Set Trigger Activation

The device supports triggering image acquisition in the rising edge, falling edge, level high, level low or any edge of the external signal. Go to **Acquisition Control** → **Trigger Activation**, and select **Rising Edge**, **Falling Edge**, **Any Edge**, **Level High**, or **Level Low** as **Trigger Activation**.

- **Rising Edge**: It means that when the level signal sent by external device is in rising edge, the device receives trigger signal and starts to acquire images.
- **Falling Edge**: It means that when the level signal sent by external device is in falling edge, the device receives trigger signal and starts to acquire images.
- **Any Edge**: It means that when the level signal sent by external device is in rising or falling edge, the device receives trigger signal and starts to acquire images.
- **Level High**: The level high of the trigger signal is valid. As long as the trigger signal is in level high, the device is in image acquisition status.
- **Level Low**: The level low of the trigger signal is valid. As long as the trigger signal is in level low, the device is in image acquisition status.

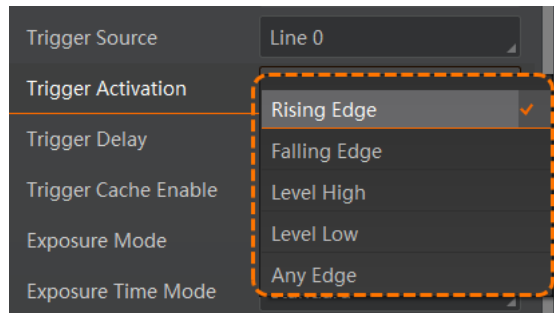

Figure 9-17 Set Trigger Activation

Note

The trigger activation mode may differ by the trigger mode.

Set Trigger Arm Delay

The function allows the device to only respond to the first received trigger signal within the configured time period and ignore all subsequent signals.

Go to **Digital IO Control** → **Line Trigger Arm Delay(μs)**, and enter **Line Trigger Arm Delay** according to actual demands. The range of **Line Trigger Arm Delay** is from 0 μs to

1000000 μ s.

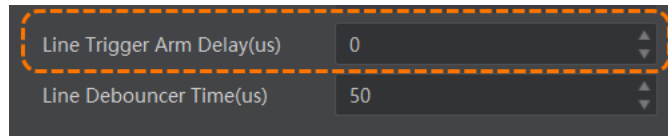

Figure 9-18 Set Trigger Arm Delay

Set Trigger Debouncer

The trigger debouncer function allows the device to filter out unwanted short external trigger signal that is input to the device.

Go to **Digital IO Control** → **Line Debouncer Time**, and enter **Line Debouncer Time** according to actual demands.

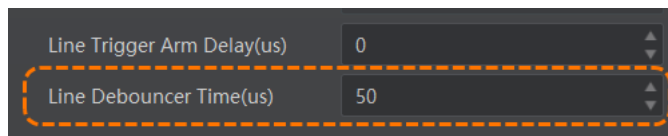

Figure 9-19 Set Trigger Debouncer

If the **Line Debouncer Time** you set is greater than the time of trigger signal, this trigger signal will be ignored.

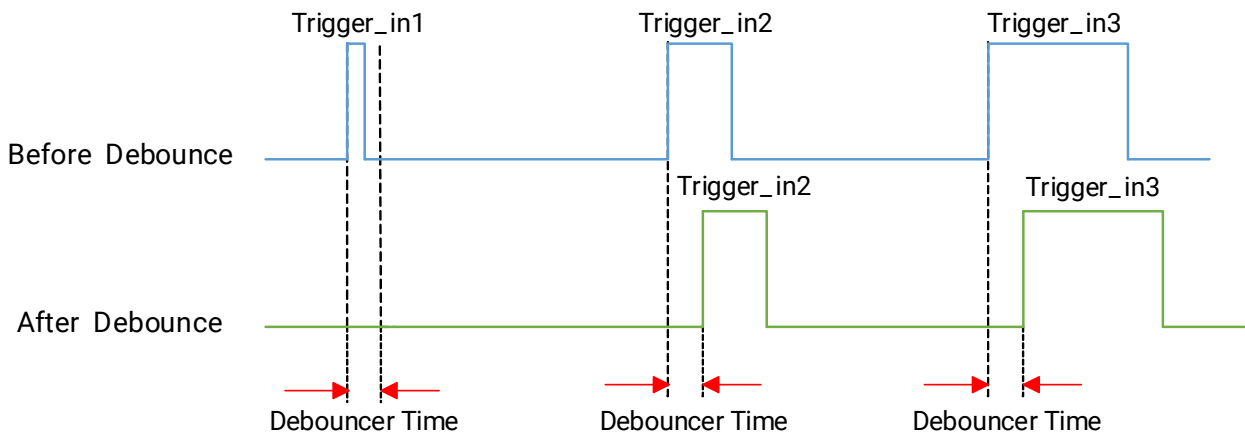

Figure 9-20 Sequence Diagram of Trigger Debouncer

Note

- The sequence diagram above uses rising edge as trigger activation.
- When you use the trigger debouncer function, there may be a delay in the signal.

9.1.4 Set Counting

The device supports incremental counting of trigger signal. Go to **Counter And Timer Control** → **Counter Selector** and select **Counter 1** to enable this function, and set related

parameters as shown below.

Table 9-4 Parameters of Counter And Timer Control

Parameter	Read/Write	Description
Counter Selector	Read & Write	<p>It selects counter source. Counter 0 and Counter 1 are available only at present.</p> <p> Note Counter 1 should be selected when counter function is executed. This table only introduces functions related to Counter 1. If you want to see functions of Counter 0, refer to section Set and Execute Counter Trigger for details.</p>
Counter Event Source	Read & Write	<p>It selects the event source of counting function. This parameter is disabled by default.</p> <p>When you select Software Signal0/1/2/3, go to Software Signal Control → Software Signal Selector to select an event source, and click Execute in Software Signal Trigger to trigger the event source.</p>
Counter Reset Source	Read & Write	<p>It selects the resetting source of counting. This parameter is disabled by default.</p> <p>When you select Software Signal0/1/2/3, go to Software Signal Control → Software Signal Selector to select a resetting source, and click Execute in Software Signal Trigger to trigger the resetting source.</p> <p>When the signal source selected in Counter Trigger Source is triggered, and Counter Active is shown in Counter Status, the counter resetting will be executed if the resetting source selected in Counter Reset Source is triggered.</p>
Counter Reset Activation	Read & Write	<p>When Line 0/2 is selected as Counter Reset Source, you can select resetting activation method.</p> <p>When the signal source selected in Counter Trigger Source is triggered, and Counter Active is shown in Counter Status, the</p>

Parameter	Read/Write	Description
		counter resetting will be executed if Line 0/2 is triggered according to the selected activation method.
Counter Trigger Source	Read & Write	<p>It selects the signal source of counting. This parameter is disabled by default.</p> <p>When you select Software Signal0/1/2/3, go to Software Signal Control → Software Signal Selector to select a signal source, and click Execute in Software Signal Trigger to trigger the signal source.</p> <p>When the signal source selected in Counter Trigger Source is triggered, and Counter Active is shown in Counter Status, the counting will be executed for the event source selected in Counter Event Source.</p>
Counter Trigger Activation	Read & Write	<p>When Line 0/2 is selected as Counter Trigger Source, you can select activation method: Rising Edge, Falling Edge, or Any Edge. The counting will be executed when Line 0/2 is in rising/falling/any edge.</p>
Counter Value	Read & Write	<p>It is the max. value of counter. If the parameter reaches to the max. value, counting will not be executed and you should reset the counter.</p>
Counter Current Value	Read Only	<p>It displays the current value of counter.</p>
Counter Reset	Read & Write	<p>It resets counter. After the counter is reset, the counter status will be changed to Counter Idle.</p> <p>This function is applicable for resetting the counter in cases other than the resetting source set in Counter Reset Source.</p> <p>If you want to disable the counter, select Off as Counter Event Source.</p>
Counter Status	Read Only	<p>It displays the current status of counter.</p> <ul style="list-style-type: none"> ● Counter Idle: The counter is in idle status. If you want to use the counter, trigger the signal source selected in Counter Trigger Source, and the counter status will be

Parameter	Read/Write	Description
		<p>changed to Counter Active.</p> <ul style="list-style-type: none"> ● Counter Active: The counter is in active status. When the event source selected in Counter Event Source is triggered, the counting will be executed. ● Counter Completed: The counter has finished tasks. At this time, the max. value of counter configured in Counter Value is reached.

9.2 Trigger Output

The device has one opto-isolated output (Line 1), and one bi-directional I/O (Line 2) that can be configured as output signal. The method of setting bi-directional configurable line as output line is as follows:

Steps

1. Go to **Digital IO Control**, and select **Line 2** as **Line Selector**.
2. Set **Strobe** as **Line Mode**.

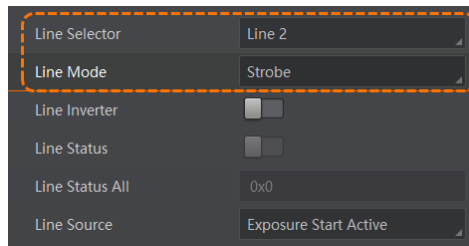

Figure 9-21 Select Output Signal

The output signal of the device is switch signal that can be used to control external devices such as light source, PLC, etc. There are two ways to set output signal, including line inverter and strobe signal.

9.2.1 Enable Line Inverter

The line inverter function allows the device to invert the electrical signal level of an I/O line.

Go to **Digital IO Control** → **Line Inverter**, and enable it.

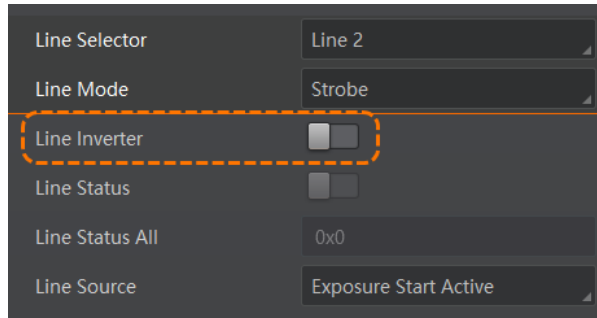

Figure 9-22 Enable Line Inverter

Note

The line inverter function is disabled by default.

9.2.2 Enable Strobe Signal

The strobe signal is used to directly output I/O signal to external devices when the device's event source occurs.

Steps

1. Go to **Digital IO Control** → **Line Source**, and select **Line Source** according to actual demands.
2. Enable **Strobe Enable**.

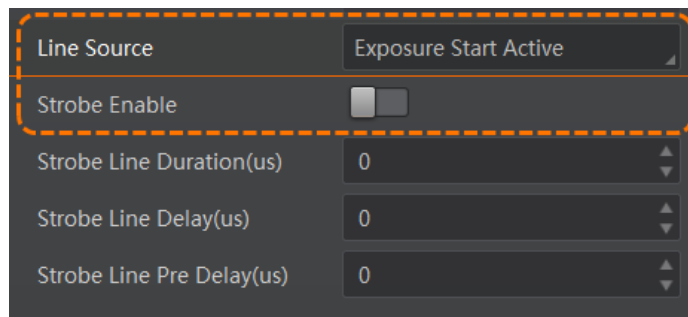

Figure 9-23 Enable Strobe Signal

The supported line sources are as follows:

Table 9-5 Line Source Description

Line Source	Description
Exposure Start Active	The device outputs signals to external devices when it starts exposure.
Exposure End Active	The device outputs signals to external devices when it stops exposure.

Line Source	Description
Acquisition Start Active	The device outputs signals to external devices when it starts acquiring images.
Acquisition Stop Active	The device outputs signals to external devices when it stops acquiring images.
Frame Burst Start Active	The device outputs signals to external devices when the device's frame burst starts.
Frame Burst End Active	The device outputs signals to external devices when the device's frame burst stops.
Frame Trigger Wait	The device is currently waiting for a frame start trigger.
Frame Start Active	The device outputs signals to external devices when it starts doing the capture of a frame.
Frame End Active	The device outputs signals to external devices when it stops doing the capture of a frame.
Soft Trigger Active	The device outputs signals to external devices when it has a software trigger.
Hard Trigger Active	The device outputs signals to external devices when it has a hardware trigger.
Counter Active	The device outputs signals to external devices when it has a counter trigger.
Timer Active	The device outputs signals to external devices when it has a timer trigger.
Timer1 Active	The device outputs signals to external devices when it has a timer 1 trigger.

 **Note**

The specific line sources may differ by device models.

- If **Timer Active** is selected as **Line Source**, you can click **Execute** in **Line Trigger Software**, and enter **Strobe Line Delay** according to actual demands. The device will output signals whose duration is configured in **Strobe Line Duration**.

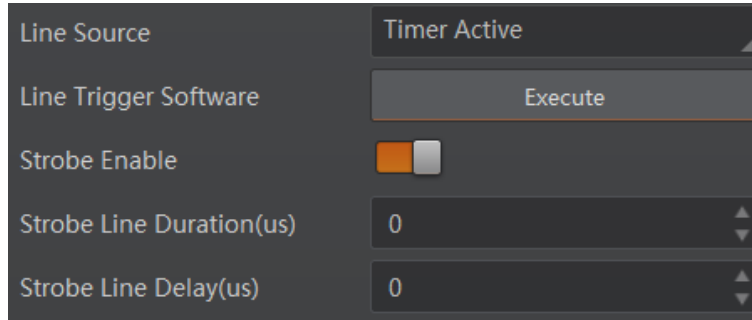

Figure 9-24 Timer Active Parameters

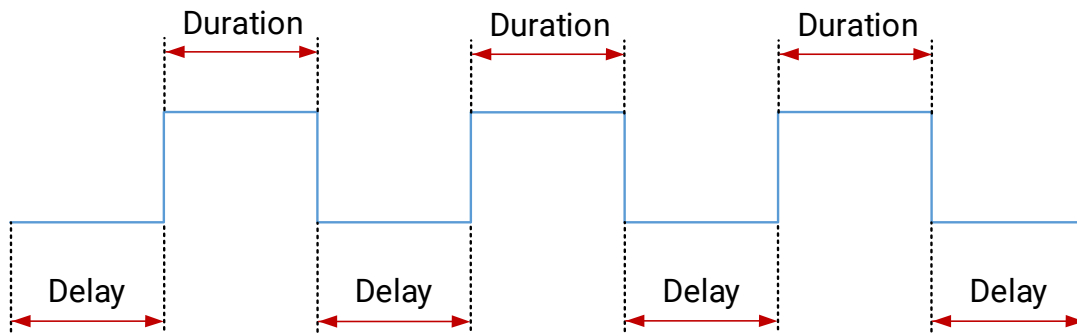

Figure 9-25 Sequence Diagram of Timer Active

- If **Timer1 Active** is selected as **Line Source**, you should set related parameters as shown below.

Table 9-6 Parameters of Timer

Parameter	Read/Write	Description
Timer Selector	Read & Write	It selects timer source. Timer 1 is available only at present.
Timer Duration(μ s)	Read & Write	It sets a duration of timer signal.
Timer Delay(μ s)	Read & Write	It sets the delay time between receiving trigger signal and starting timer.
Timer Reset	Read & Write	It resets the timer.
Timer Value	Read & Write	It is the timer value. If the parameter is set to n, the n external trigger signals can perform one timer trigger and acquire one frame of image.
Timer Current Value	Read Only	It displays the current value of timer.
Timer Status	Read Only	It displays the current status of timer.
Timer Trigger Source	Read & Write	It selects the signal source of timer. This parameter is disabled by default.

Parameter	Read/Write	Description
		When you select Software Signal0/1/2/3 , go to Software Signal Control → Software Signal Selector to select a signal source, and click Execute in Software Signal Trigger to trigger the signal source.
Timer Trigger Activation	Read & Write	When Line 0/2, Acquisition Active, Frame Burst Active, Exposure Active, or Frame Trigger Wait is selected as Timer Trigger Source , you can select activation method: Rising Edge, Falling Edge, or Any Edge . The timer will receive and trigger the signal when the level signal is in rising/falling/any edge.
Timer Trigger Arm Delay(μs)	Read & Write	It sets delay time of timer. The timer will receive the signal after the set time.

Set Strobe Line Duration

After enabling strobe signal, you can set its duration. Go to **Digital IO Control** → **Strobe Line Duration**, and enter it according to actual demands.

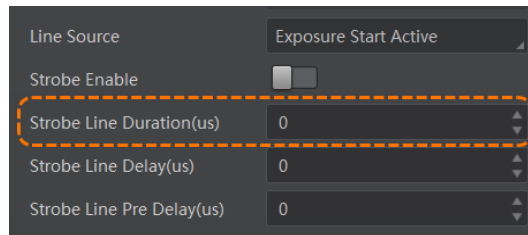

Figure 9-26 Set Strobe Line Duration

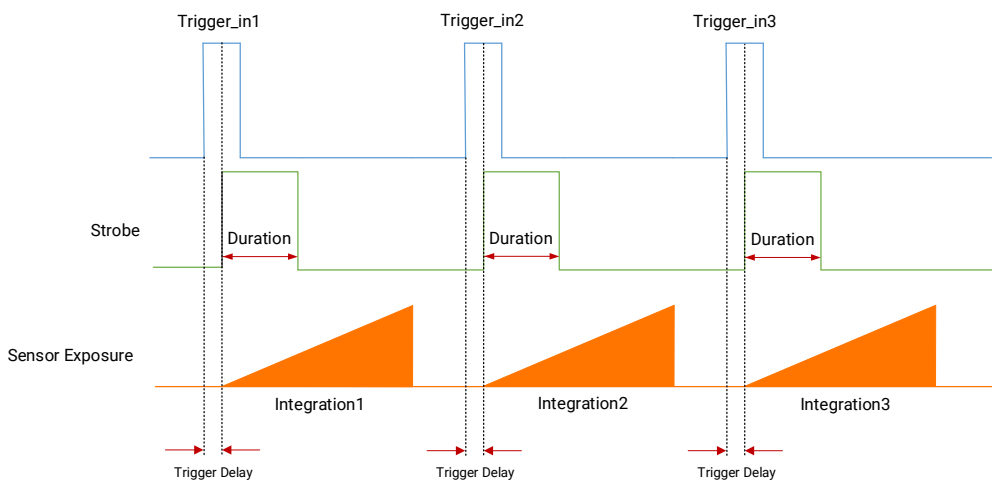

Figure 9-27 Sequence Diagram of Strobe Line Duration

Note

- When **Strobe Line Duration** value is 0, the strobe duration is equal to the exposure time.
- When **Strobe Line Duration** value is not 0, the strobe duration is the value you set.

Set Strobe Line Delay

The device supports setting strobe line delay to meet actual demands. When exposure starts, the strobe output does not take effect immediately. Instead, the strobe output will delay according to the strobe line delay settings.

Go to **Digital IO Control** → **Strobe Line Delay**, and enter it according to actual demands. The range of **Strobe Line Delay** is from 0 μ s to 10000 μ s.

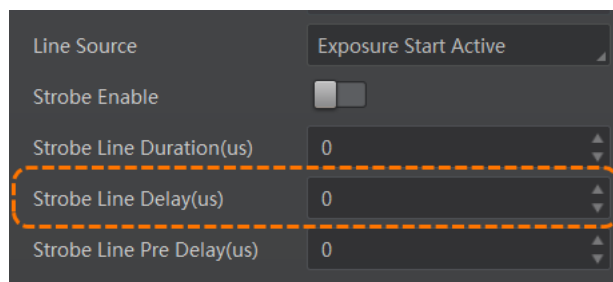

Figure 9-28 Set Strobe Line Delay

Take **Exposure Start Active** selected as an example. When the exposure starts, the strobe output is delayed based on the value set in **Strobe Line Delay**. The sequence diagram of strobe line delay is shown below.

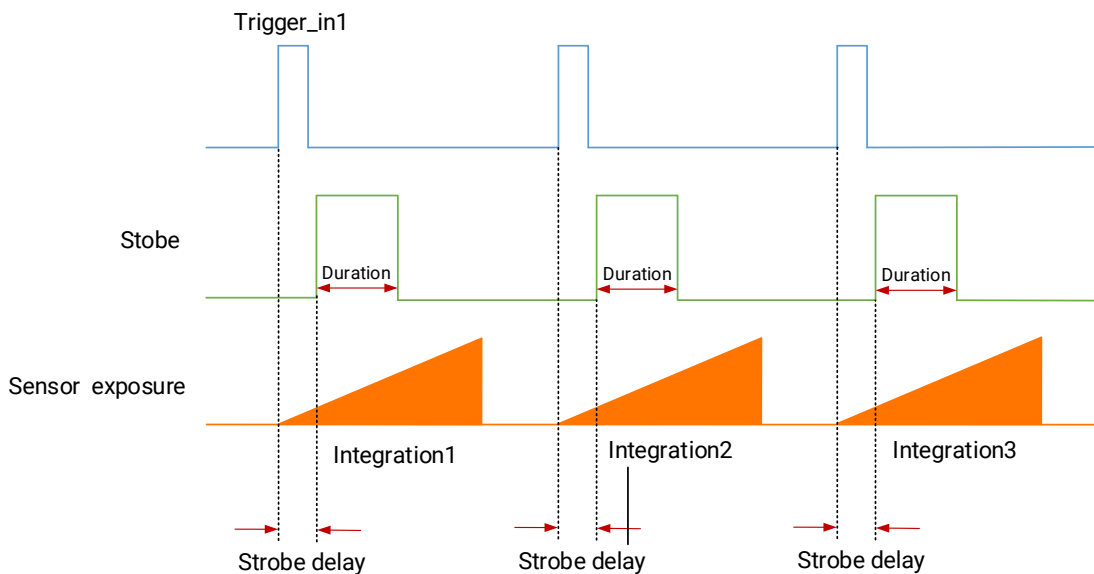

Figure 9-29 Sequence Diagram of Strobe Line Delay

Set Strobe Line Pre Delay

The device also supports the function of strobe line pre delay, which means that the strobe signal takes effect early than exposure. This function is applied to the external devices that have slow response speed.

Click **Digital IO Control** → **Strobe Line Pre Delay**, and enter **Strobe Line Pre Delay** according to actual demands. The range of **Strobe Line Pre Delay** is from 0 μs to 5000 μs.

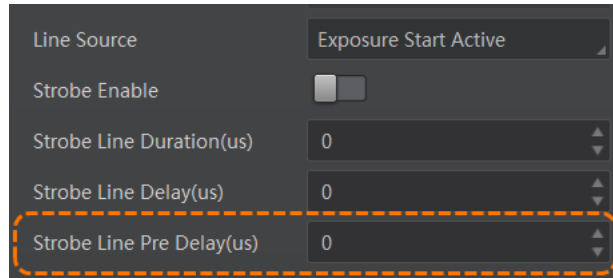

Figure 9-30 Set Strobe Pre Line Delay

Taking **Exposure Start Active** selected as an example, the device will delay exposure start time based on the value set in **Strobe Line Pre Delay**. The sequence diagram of strobe line pre delay is shown below.

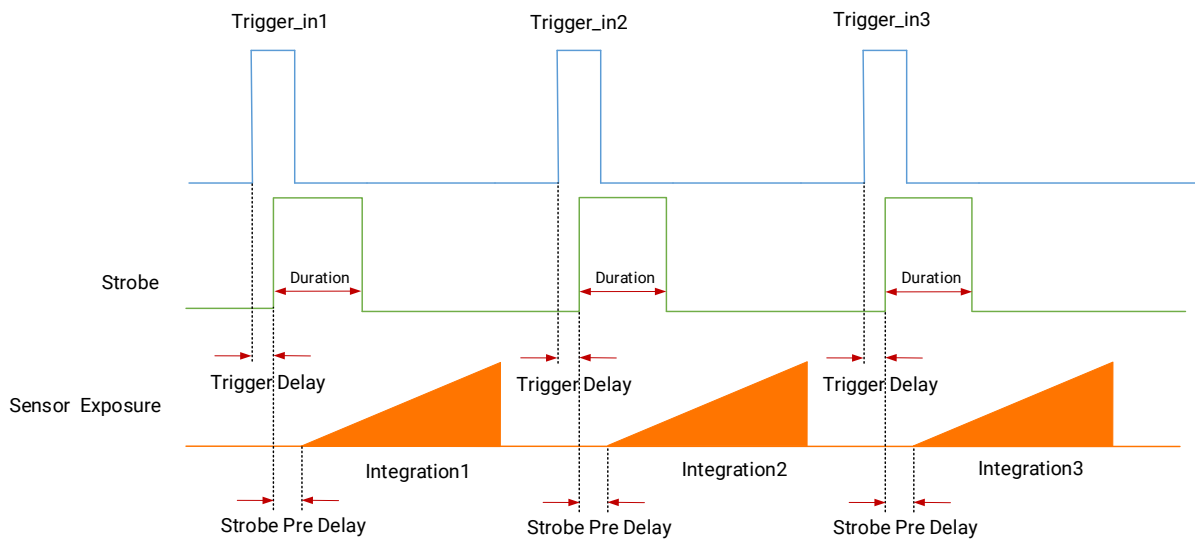

Figure 9-31 Sequence Diagram of Strobe Pre Line Delay

Chapter 10 Image Acquisition and Transmission

10.1 Global Shutter and Rolling Shutter

The shutter mode of the device is divided into global shutter and rolling shutter. The shutter mode is determined by the characteristics of the sensor used by the device.

10.1.1 Global Shutter

For device that supports global shutter, its exposure starts and ends in each line simultaneously. After the exposure, data readout starts line by line. All pixels expose at the same time, and then read out at different time.

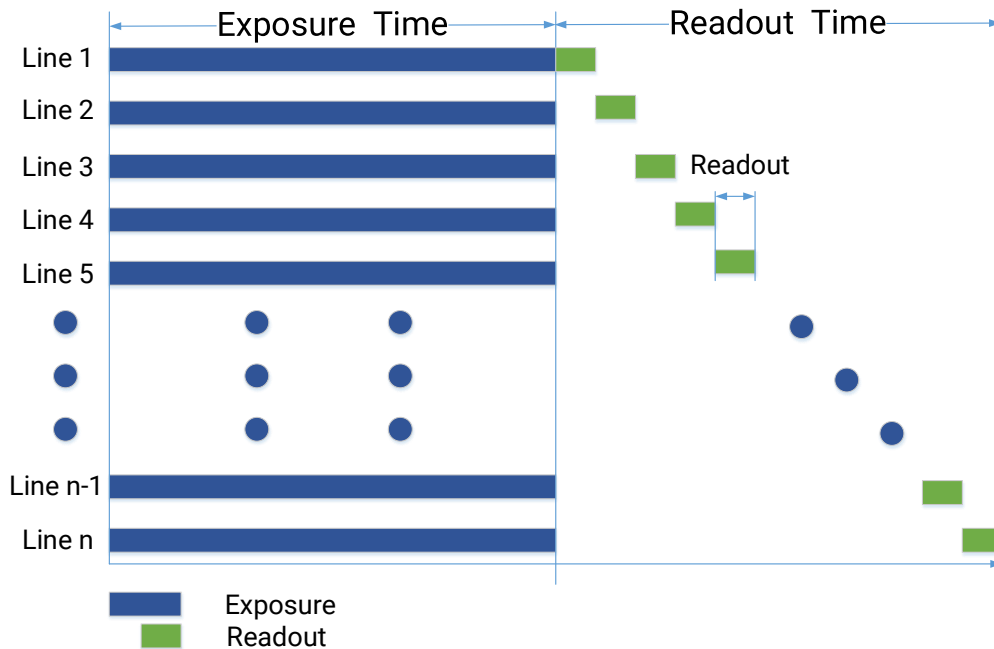

Figure 10-1 Global Shutter

10.1.2 Rolling Shutter

Working Principle

For device that supports rolling shutter, as soon as the exposure ends, the data readout starts simultaneously. After the whole action, the rest of rows start to expose and read out one by one. All pixels expose at the same time, and then read out at different time.

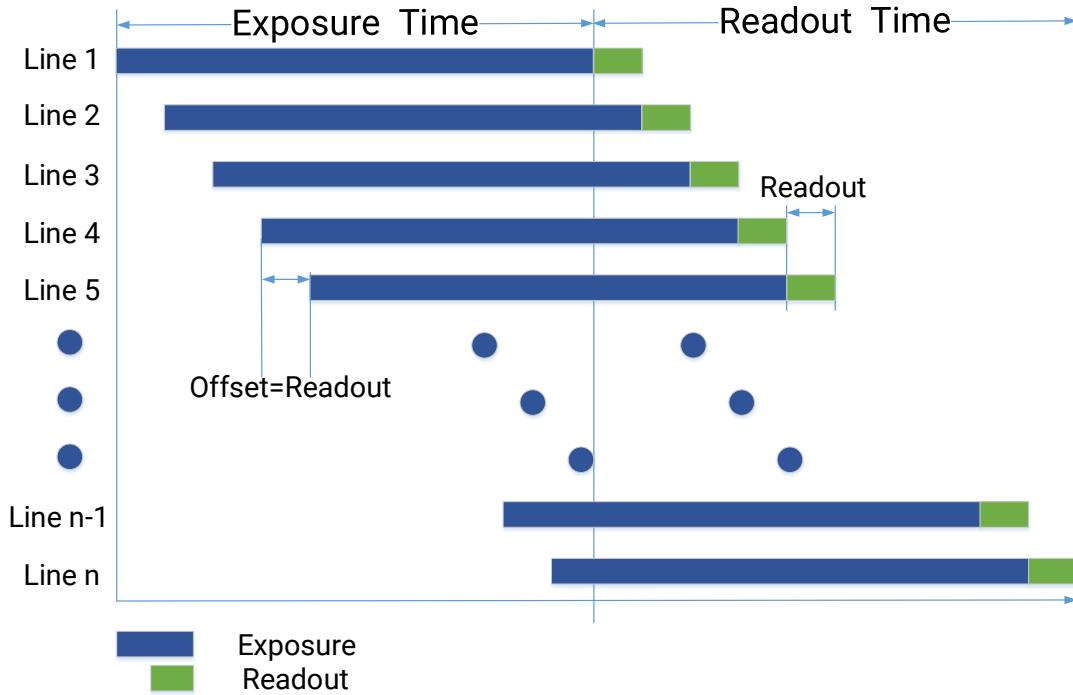

Figure 10-2 Rolling Shutter

Global Reset

Global reset means that all of the sensor's pixels start exposing at the same time, but stop exposing at different time.

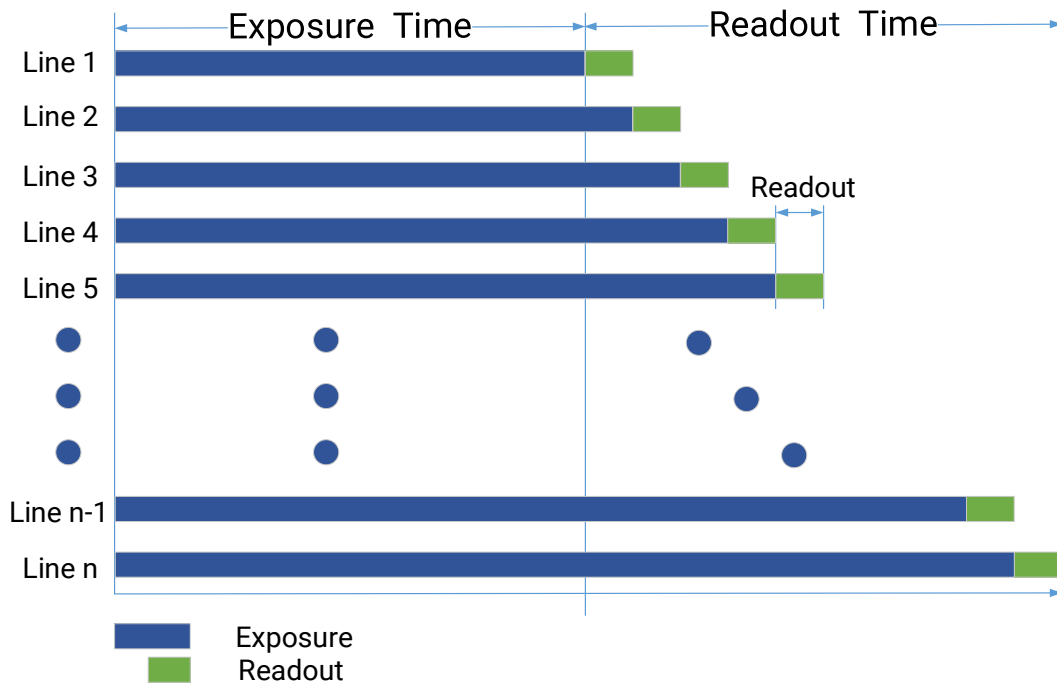

Figure 10-3 Global Reset

You can go to **Acquisition Control** → **Sensor Shutter Mode**, and select **Global Reset** as **Sensor Shutter Mode**.

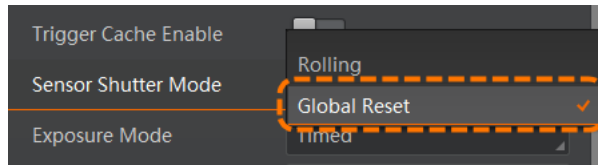

Figure 10-4 Select Global Reset

Note

When Global Reset function is enabled, different exposure times for each line of the image may result in different brightness of each line. Therefore, it is recommended to use this function together with an industrial light source in a completely dark environment. By enabling the light source during the exposure time and disabling at other times, each line of the image will be illuminated equally during the same exposure time.

10.2 Acquisition Mode

The device supports two types of acquisition modes, including **SingleFrame** mode and **Continuous** mode. Go to **Acquisition Control** → **Acquisition Mode**, and select **Continuous** or **SingleFrame** as **Acquisition Mode** according to actual demands.

- **SingleFrame**: When device starts image acquisition, it acquires one image only, and then stops.
- **Continuous**: When device starts image acquisition, it acquires images continuously. Real-time frame rate decides the acquisition frame number per second. You can stop image acquisition manually.

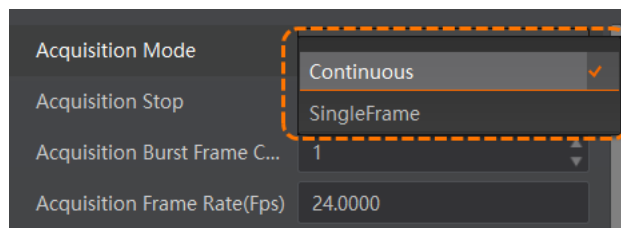

Figure 10-5 Set Acquisition Mode

10.3 Acquisition Burst Mode

The acquisition burst mode includes **Standard** and **High Speed**. Go to **Acquisition Control** → **Acquisition Burst Mode** to set according to actual demands.

Note

The acquisition burst mode is supported when **Frame Burst Start** is selected as **Trigger**

Selector and Trigger Mode is On.

- **Standard:** In this mode, the device acquires images in a normal speed.
- **High Speed:** In this mode, the device acquires images in a higher speed, but the transmission speed is unchanged. This mode is only available to scenarios of temporary over-bandwidth transmission in frame trigger mode, and not available to scenarios of continuous over-bandwidth transmission.

After you select **High Speed**, the following parameters can be viewed.

- Resulting Acquisition Frame Rate: It is the actual acquisition frame rate in high speed mode.
- Resulting Transfer Frame Rate: It is the actual transmission frame rate in high speed mode.
- Resulting Frame Burst Rate: It is the max. number of triggers per second supported by the device in high speed mode.

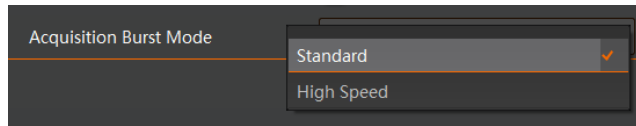

Figure 10-6 Internal Trigger Overlap Exposure

10.4 Set Frame Rate

Frame rate refers to the image quantity that is acquired by the device per second. The higher frame rate, and shorter time used for image acquisition will be. The following factors determine the device's frame rate in real-time.

- Frame readout time: The frame readout time is related with device's sensor performance and image height. The lower the image height and less the frame readout time, and the higher the frame rate will be.
- Exposure time: If the reciprocal of max. frame rate that the device supports is t , and when the configured exposure time is larger than t , the less the exposure time, the higher the frame rate will be. When the configured exposure time is less than or equal to t , exposure time will not influence the frame rate.
- Bandwidth: The larger the bandwidth, the higher the frame rate will be.
- Pixel format: The more bytes pixel format occupy, the lower the frame rate will be.
- Image compression mode: This function is used to compress data before transmitting to the PC and output original image data combined with our company's SDK, increasing the frame rate to some extent.

 **Note**

The image compression function may differ by device models. Refer to section [Set Image Compression Mode](#) for details.

Steps

1. Go to **Acquisition Control** → **Acquisition Frame Rate**, and enter **Acquisition Frame Rate**.
2. Enable **Acquisition Frame Rate Control Enable**.

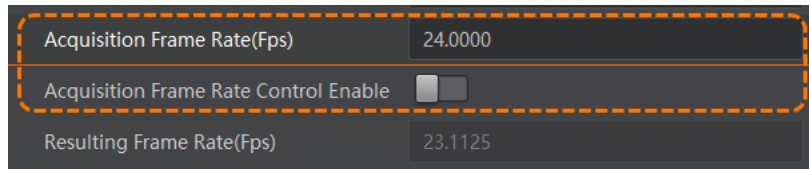

Figure 10-7 Set Frame Rate

Note

- If the real-time frame rate is smaller than the value you set, the device acquires images by the real-time frame rate.
 - If the real-time frame rate is larger than the value you set, the device acquires images by the value you set.
3. When the image compression mode is enabled, you can view the **Reference Frame Rate** for reference. This parameter is a reference frame rate calculated by the device based on theoretical bandwidth and compression ratio. It does not affect image output control and is displayed for reference purposes only.
 4. View the device's final frame rate in **Resulting Frame Rate**.

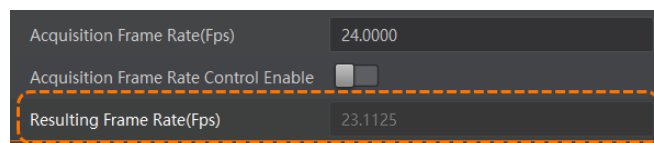

Figure 10-8 View Resulting Frame Rate

Chapter 11 Image Parameter

11.1 Set Resolution and ROI

Note

The device displays the image with max. resolution by default.

Go to **Image Format Control**, and you can view resolution by reading **Width Max** and **Height Max**. **Width Max** stands for the max. pixels per inch in width direction, and **Height Max** stands for the max. pixels per inch in height direction.

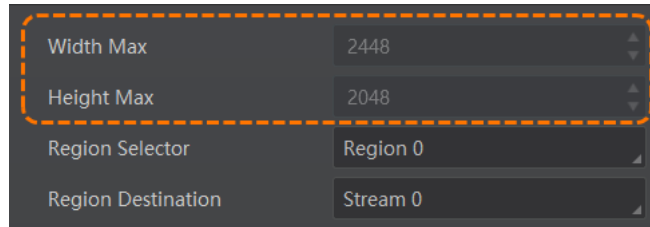

Figure 11-1 View Resolution

If you are only interested in a certain region of the image, you can set a Region of Interest (ROI) for the device.

When you are only interested in some details in the image, image cropping is needed. That is, an ROI setting is performed on the device to output an image of the region of interest. Setting the region of interest can reduce the transmission data bandwidth and may improve the device’s frame rate to a certain extent.

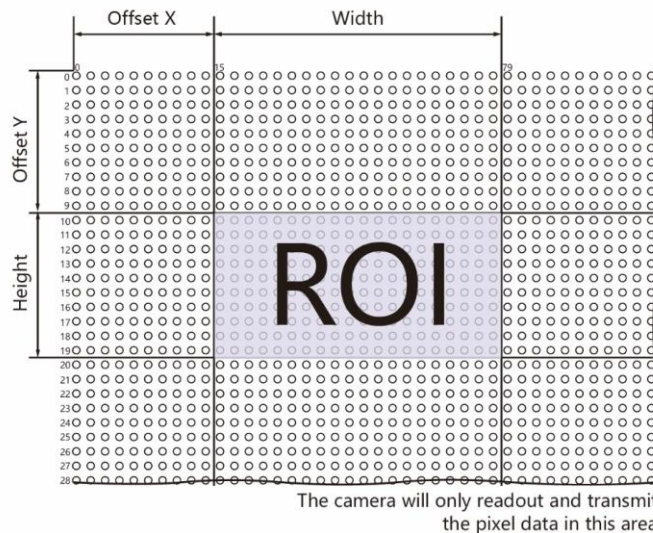

Figure 11-2 ROI

Note

- Region of interest can be set only when you stop real-time acquisition.
- The device currently supports one ROI only, and you can select **Region 0** as **Region Selector**.

Go to **Image Format Control** → **Region Selector**, and enter **Width**, **Height**, **Offset X**, and **Offset Y**.

- **Width**: It stands for horizontal resolution in ROI area.
- **Height**: It stands for vertical resolution in ROI area.
- **Offset X**: It refers to the horizontal coordinate of the upper-left corner of the ROI.
- **Offset Y**: It refers to the vertical coordinate of the upper-left corner of the ROI.

Note

- The **Width** plus **Offset X** should not be larger than **Width Max**, and **Height** plus **Offset Y** not be larger than **Height Max**.
- During ROI settings, parameter stepping may differ by device model.

11.2 Set Image Reverse

Note

For different models of device, the image reverse function may be different, please refer to the actual one you got.

Reverse X refers to the image reverses in a horizontal way, and **Reverse Y** refers to the image reverses in a vertical way.

You can click **Image Format Control**, and enable **Reverse X** or **Reverse Y** according to actual demands.

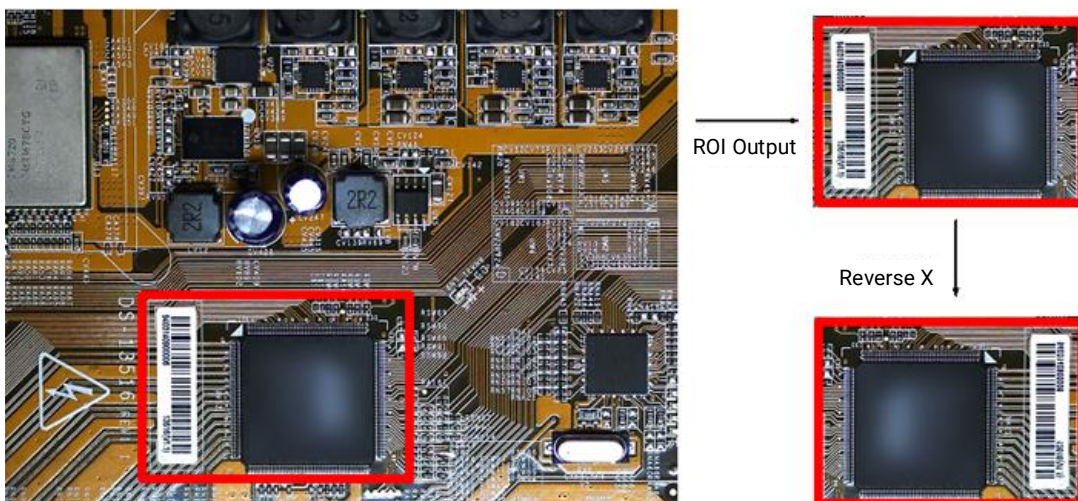

Figure 11-3 Image Reverse Comparison (Reverse X as an Example)

11.3 Set Rotation

Some device models support this function which allows you to rotate the image in counterclockwise. Go to **Image Format Control** → **Rotation**, and select 0/90/180/270 as a rotation angle.

Note

- When 90/180/270 is selected, functions including setting resolution, image reverse, and pixel format are unavailable.
 - When 90/270 is selected, the device's frame rate will be reduced. The reduction value may differ by device models.
 - The rotation angle may differ by the device model, or settings of pixel format and HB image compression mode.
 - The rotation function is not supported if parameters of image reverse are enabled.
 - The rotation function is not supported if some devices start image acquisition.
-

11.4 Set Pixel Format

This function allows you to set the pixel format of the image data transmitted by the device. Go to **Image Format Control** → **Pixel Format**, and set **Pixel Format** according to actual demands.

Note

- The specific pixel formats may differ by device models.
 - With different ADC bit depth, the pixel format and pixel size may differ.
-

Table 11-1 Pixel Format and Pixel Size

ADC Bit Depth	Pixel Format	Pixel Size (Bits/Pixel)
12	Mono 8, Bayer 8	8
	Mono10 Packed, Mono 12 Packed, Bayer 10 Packed, Bayer 12 Packed	12
	Mono 10/12, Bayer 10/12, YUV422Packed, YUV 422 (YUYV) Packed	16
	RGB 8, BGR 8	24

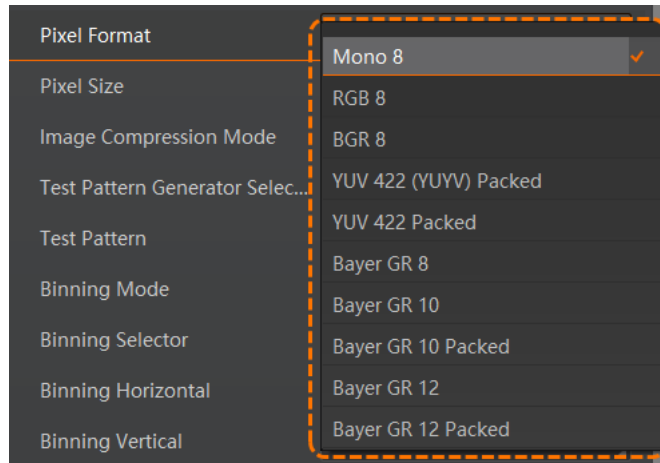

Figure 11-4 Set Pixel Format

With different ADC bit depths and pixel formats, the device's max. frame rate may differ. The larger the device's ADC bit depth value, the better the device's image quality, and the lower the device's frame rate will be.

Note

The ADC bit depth function may differ by device models.

The default output data format of mono device is Mono 8. The default output data format of color device is Bayer 8, and it can be converted into RGB format via pixel interpolation algorithm. The RGB format can be converted into YUV format, and Y component of YUV can be output as Mono 8 format.

Note

If there is no need to identify the color of the object, it is recommended to use a mono camera.

Bayer GR, Bayer GB, Bayer BG, and Bayer RG patterns are shown below.

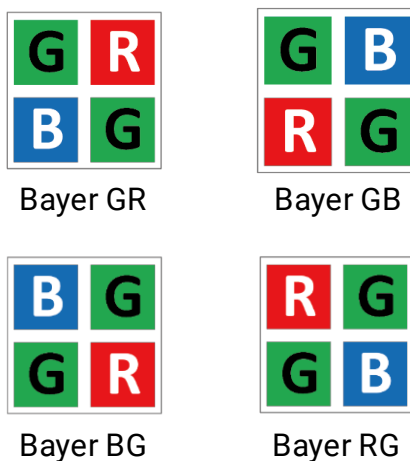

Figure 11-5 Pixel Patterns

In Bayer pixel format, some color devices support Gamma function, sharpness, contrast ratio, super palette control, CCM, and LUT function after you enable **Super Bayer Enable**. Go to **Image Format Control** → **Super Bayer Enable**, and enable it according to actual demands.

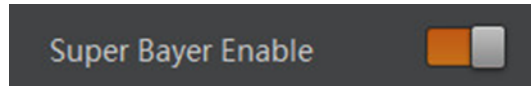

Figure 11-6 Set Super Bayer

Note

- For different models of device, the super Bayer function may be different. Refer to the actual one you got.
 - The super Bayer function is only valid in the Bayer pixel format.
 - After you enable the super Bayer function, the related functions will be shown in the feature tree. If you select other pixel formats, you can set the related parameters under the pixel format.
 - The frame rate is the same in the Bayer pixel format before and after you enable the **Super Bayer Enable**.
-

11.5 Set Image Compression Mode

Some device models support two image compression methods: lossless compression and lossy compression.

Note

The function of the image compression is related to device models, firmware and pixel format, and the actual device you purchased should prevail.

11.5.1 Set Lossless Compression Mode

Without affecting image quality, this function allows the device to compress data before transmitting to the PC, and output original image data via our company's SDK.

Go to **Image Format Control** → **Image Compression Mode**, and select **HB** as **Image Compression Mode**.

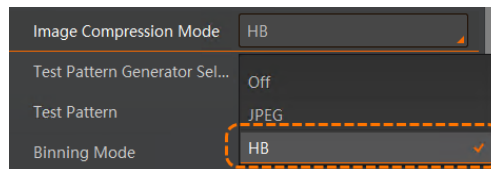

Figure 11-7 Set Image Compression Mode

11.5.2 Set Lossy Compression Mode

The lossy compression function allows the device to discard non-critical visual information for efficient compression, increasing image transmission frame rate. After the processed data is transmitted to the PC, it can be decompressed and restored into an image via our company's SDK. However, this process will result in the permanent loss of some original details.

Go to **Image Format Control** → **Image Compression Mode**, and select **JPEG** as **Image Compression Mode**.

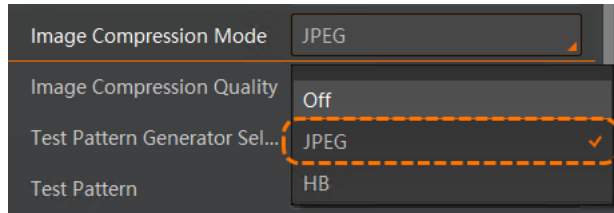

Figure 11-8 Set Image Compression Mode

You can set **Image Compression Quality** according to actual demands and the parameter should be between 1 and 99. The higher the value, the less detail loss in the image, but the lower frame rate improvement of image transmission.

Note

- When the lossy compression function and rotation function are enabled at the same time, the frame rate improvement of image transmission is not supported. Refer to section [Set Rotation](#) for details.
 - The lossy compression function is valid in Mono and YUV422Packed pixel formats.
-

11.6 Set Test Pattern

Note

The test pattern may differ by device models.

The device supports test pattern function. When there is an exception in real-time image, you can check whether image of test mode have similar problem to determine the reason. This function is disabled by default, and at this point, the output image by the device is real-time image. If this function is enabled, the output image by the device is test image. Go to **Image Format Control** → **Test Pattern**, and set **Test Pattern** according to actual demands. The supported patterns are shown below.

Note

- The mono device does not support the patterns of color device.
 - The supported patterns may differ by the device model.
 - The pattern of the test image 1 may differ by device models.
-

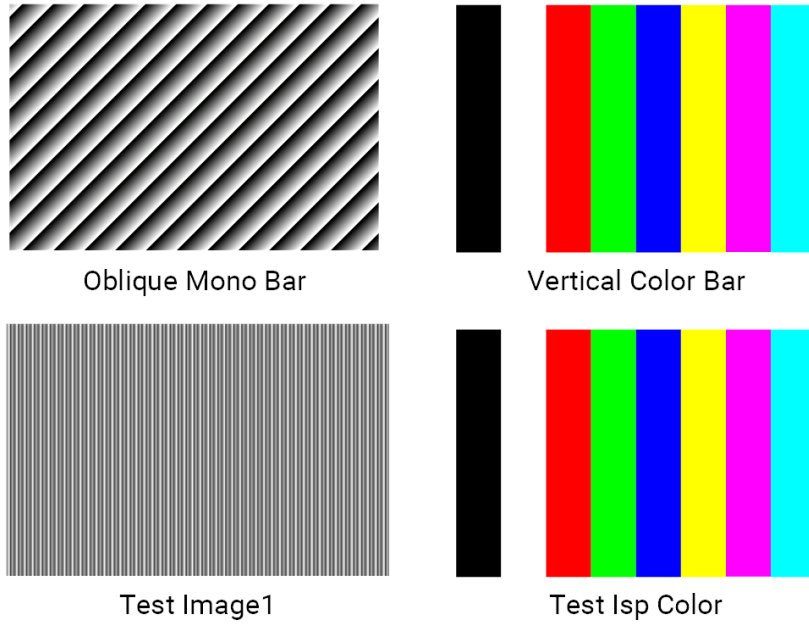

Figure 11-9 Test Patterns

11.7 Set Binning

The purpose of setting binning is to enhance sensibility. With binning, multiple sensor pixels are combined as a single pixel to reduce resolution and improve image brightness. The device can merge the pixel values of adjacent pixels of the same color horizontally or vertically, as shown below.

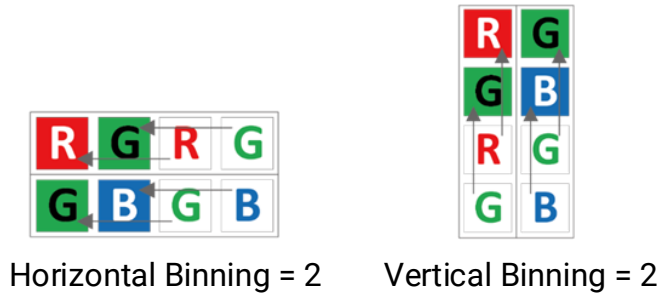

Figure 11-10 Binning Settings (Color Device as an Example)

If the horizontal binning coefficient and the vertical binning coefficient of the device are both configured to 2, the device merges the 4 adjacent sub-pixels of the same color according to the corresponding position, and outputs the merged pixel value as a sub-

pixel, as shown below.



Figure 11-11 Horizontal/Vertical Binning 2 × 2 (Color Device as an Example)

Click **Binning Selector**, and set **Binning Horizontal** and **Binning Vertical** according to actual demands.

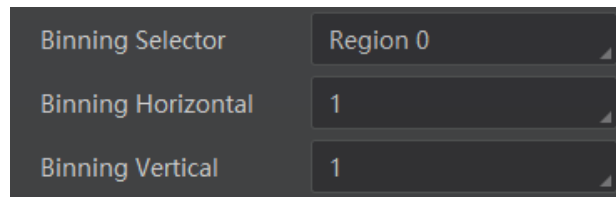

Figure 11-12 Set Binning

Note

- **Binning Horizontal** is the image’s width and offset X, and **Binning Vertical** is the image’s height and offset Y.
- The binning function may differ by device models.

Some devices also support binning mode function. Click **Binning Mode**, and select **Sum** or **Average** according to actual demands.

- **Sum**: The values of the affected pixels are summed. This improves the signal-to-noise ratio, but also increases the device’s response to light.
- **Average**: The values of the affected pixels are averaged. This greatly improves the signal-to-noise ratio without affecting the device’s response to light.

Both binning modes (Sum and Average) reduce the amount of image data to be transferred.

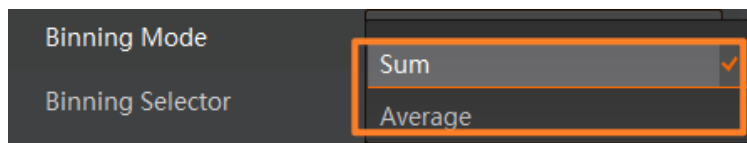

Figure 11-13 Set Binning Mode

11.8 Set Decimation

The decimation feature allows you to reduce the number of sensor pixel columns or rows that are transmitted by the device. This procedure is also known as subsampling. It

reduces the amount of data to be transferred and may increase the device's frame rate. Click **Image Format Control**, and set **Decimation Horizontal** and **Decimation Vertical** according to actual demands.

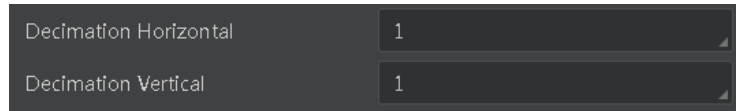

Figure 11-14 Set Decimation

Note

- **Decimation Horizontal** is the image's width and offset X, and **Decimation Vertical** is the image's height and offset Y.
 - The decimation function may differ by device models.
-

11.9 Set Exposure Mode

The device supports 3 types of exposure modes, including **Timed**, **Trigger Width**, and **Trigger Controlled**.

- If the **Exposure Mode** is **Timed**, the device's exposure time is controlled by **Exposure Auto** and **Exposure Time**.

In this mode, the device supports 3 types of exposure mode, including **Off**, **Once** and **Continuous**. Click **Acquisition Control** → **Exposure Auto**, and select **Exposure Auto** according to actual demands.

- **Off**: The device exposures according to the value set in **Exposure Time(μs)**.
- **Once**: The device adjusts the exposure time automatically according to the image brightness. After adjustment, it will switch to **Off** mode.
- **Continuous**: The device adjusts the exposure time continuously according to the image brightness.

When the exposure mode is set as **Once** or **Continuous**, the exposure time should be within the range of **Auto Exposure Time Lower Limit(μs)** and **Auto Exposure Time Upper Limit(μs)**.

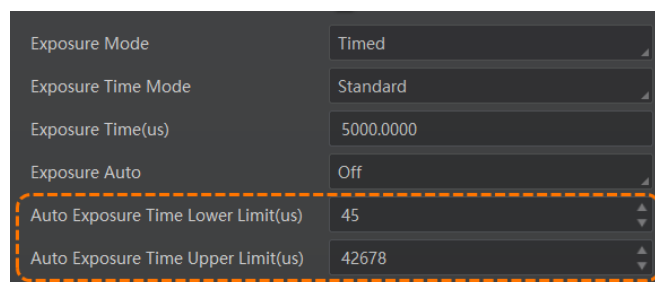

Figure 11-15 Set Exposure Time Under Once or Continuous Mode

Note

The adjustment of exposure mode may affect the brightness of the device.

- If the **Exposure Mode** is **Trigger Width**, exposure time and level signal duration should be the same, and **Exposure Auto** and **Exposure Time** are invalid.
-

Note

When the device's **Trigger Mode** is **On**, **Trigger Source** is **Line 0** or **Line 2**, and **Trigger Activation** is **Level High** or **Level Low**, **Trigger Width** can be selected as **Exposure Mode** and the device's exposure time is controlled by the signal duration.

- If the **Exposure Mode** is **Trigger Controlled**, the exposure time is related to the time when the device receives an external trigger signal, and **Exposure Auto** and **Exposure Time** are invalid.
 - In **Exposure Start** mode, the device will start exposure when it receives the configured trigger signal.
 - In **Exposure End** mode, the device will end exposure when it receives the configured trigger signal.
-

Note

- **Exposure Start** mode and **Exposure End** mode should be configured simultaneously. If only **Exposure Start** mode is set, the device will execute continuous exposure. If only **Exposure End** mode is configured, there are no exposure and no image output.
 - It is not recommended to configure the same signal source and the same trigger polarity for both **Exposure Start** mode and **Exposure End** mode. Because under this condition, when the device simultaneously receives start and end signals, it will only take effect according to the minimum exposure time of the sensor and output images.
 - When **Exposure Start** or **Exposure End** is selected in **Trigger Selector**, and **Trigger Mode** is **On**, the **Exposure Mode** will be automatically set to **Trigger Controlled**, and **Timed** or **Trigger Width** cannot be set.
 - Refer to section [Set Trigger Mode](#) for details.
-

11.10 Set Gain

The device has 2 types of gain, including the analog gain and digital gain. The analog gain is applied before the signal from the device sensor is converted into digital values, while digital gain is applied after the conversion.

When increasing gain, the image noise will increase too, which will influence image quality. If you want to increase image brightness, it is recommended to increase the device's exposure time first. If the exposure time reaches its upper limit, and at this point, you can increase gain. It is recommended to use analog gain first, and then to adjust digital gain if

the analog gain cannot meet demands.

11.10.1 Set Analog Gain

Note

The range of analog gain may differ by device models. Refer to device's specification for details.

The device supports 3 types of gain mode, including **Off**, **Once** and **Continuous**. Click **Analog Control** → **Gain Auto**, and select **Gain Auto** according to actual demands.

- **Off**: The device adjusts gain according to the value configured by user in **Gain**.
- **Once**: The device adjusts the gain automatically according to the image brightness. After adjusting, it will switch to **Off** mode.
- **Continuous**: The device adjusts the gain continuously according to the image brightness.

When the gain mode is set as **Once** or **Continuous**, the gain should be within the range of **Auto Gain Lower Limit (dB)** and **Auto Gain Upper Limit (dB)**.

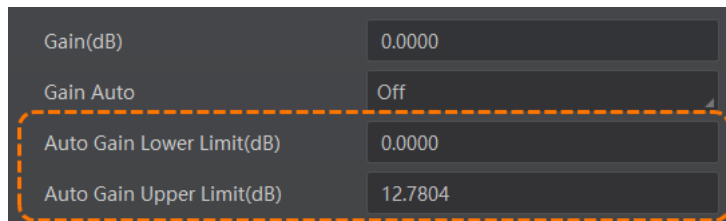

Figure 11-16 Set Gain under Once or Continuous Mode

11.10.2 Set Digital Gain

Apart from analog gain, the device supports digital gain function. When analog gain reaching its upper limit and the image is still too dark, it is recommended to improve image brightness via digital gain.

Click **Analog Control**, enable **Digital Shift Enable**, and enter **Digital Shift** according to actual demands.

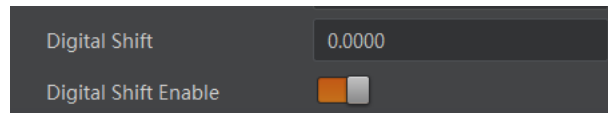

Figure 11-17 Set Digital Gain

Note

- The value in **Digital Shift** is between -24 dB and 24 dB, and is 0 by default.
 - **Digital Shift Enable** is disabled by default.
-

11.11 Set Brightness

The device brightness refers to the brightness when the device adjusts image under **Once** or **Continuous** exposure mode.

Note

- You should enable **Once** or **Continuous** exposure mode or gain mode first before setting brightness. Refer to section [Set Exposure Mode](#) and section [Set Analog Gain](#) for details.
- After setting brightness, the device will automatically adjust exposure time or analog gain to let image brightness reach target one. Under **Once** or **Continuous** exposure mode, the higher the brightness value, the brighter the image will be under auto exposure mode or auto gain mode.
- The range of brightness is between 0 and 255.



Figure 11-18 Brightness Example

Go to **Analog Control** → **Brightness**, and enter **Brightness** according to actual demand.

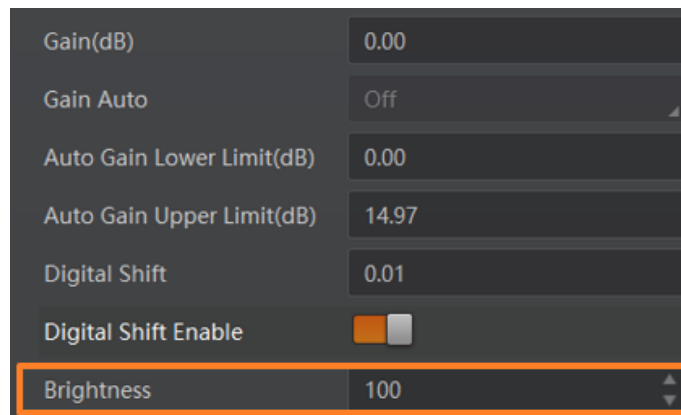

Figure 11-19 Set Brightness

11.12 Set Sharpness

Note

- The sharpness function is valid in Mono and YUV pixel formats, and is disabled by

default.

- Regarding the color device in Bayer 8 pixel format, you need to enable **Super Bayer Enable** first before using sharpness function.
-

The device supports sharpness function that can adjust the sharpness level of the image edge. You can set sharpness as shown below.

Go to **Analog Control** → **Sharpness Enable**, enable **Sharpness Enable**, and enter **Sharpness** according to actual demands.

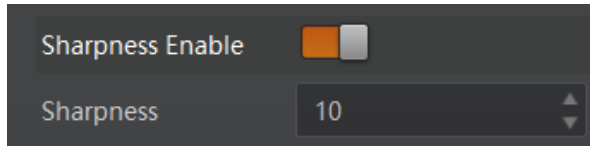

Figure 11-20 Set Sharpness

11.13 Set Contrast Ratio

Note

- Make sure that the live view is enabled, and Gamma correction and LUT function are disabled before using the contrast ratio function.
 - Regarding the color device in Bayer pixel format, you need to enable **Super Bayer Enable** first before using contrast ratio function.
-

The device supports the contrast ratio function that adjusts the intensity of light/darkness and color. The larger the contrast ratio, and more clear the image is.

Go to **Analog Control**, enable **Contrast Ratio Enable**, and set **Contrast Ratio** according to actual demands.



Figure 11-21 Set Contrast Ratio

11.14 Set LCE Mode

The LCE mode allows the device to adaptively enhance local contrast in low-light or unevenly-lit scenarios. It increases the brightness of the dark areas in the image while keeping the brightness of the bright areas unchanged.

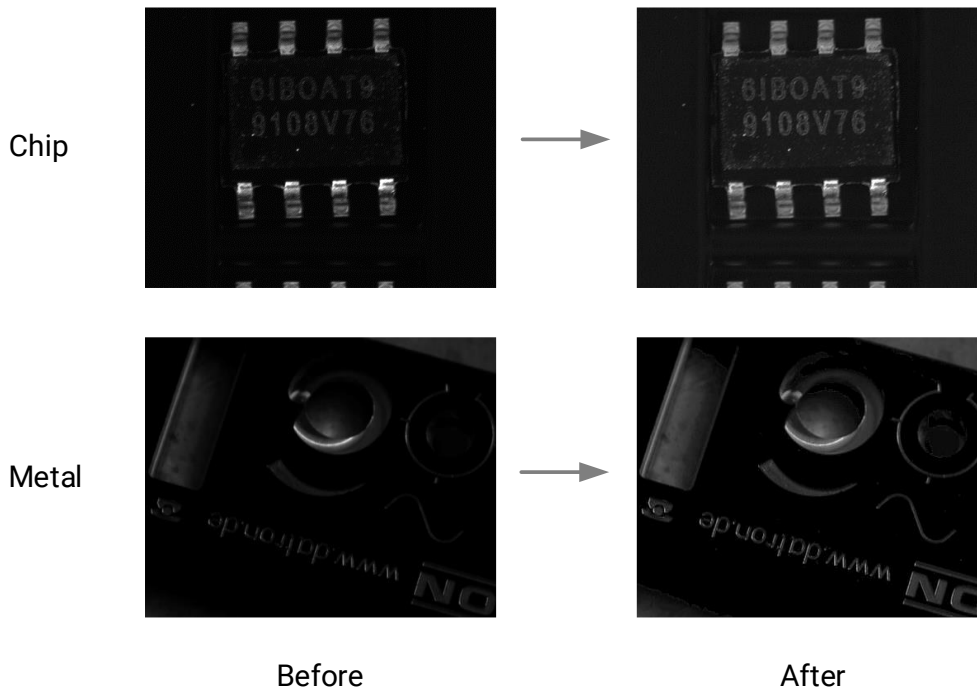

Figure 11-22 LCE Mode Example

Go to **Analog Control**, select **On** in **LCE Mode**, and set related parameters according to actual demands.

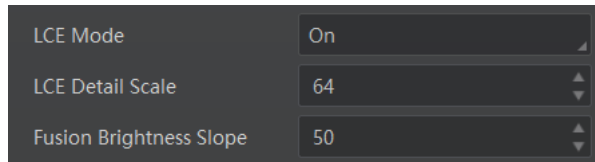

Figure 11-23 Set LCE Mode

- **LCE Detail Scale:** It sets the fusion ratio of image details. The higher the value, the stronger the enhancement of texture details and the higher the sharpening intensity.
- **Fusion Brightness Slope:** It sets the image brightness. The lower the value, the stronger brightness effects.

11.15 Set White Balance

Note

White balance is only available for color devices. In Mono pixel format, this function is not supported.

The white balance refers to the device color adjustment depending on different light

sources. Adjust the R/G/B ratio to ensure that the white regions are white under different color temperatures. Ideally, the proportion of R/G/B in the white region is 1:1:1. The device supports 3 types of white balance mode, including **Off**, **Once** and **Continuous**. Click **Analog Control** → **Balance White Auto**, and select **Balance White Auto** according to actual demands.

- **Off**: You need to set the R, G, B ratio manually via **Balance Ratio Selector** and **Balance Ratio**. The value of 1024 means ratio is 1.0.
- **Once**: Adjust the white balance for a certain amount of time then stop.
- **Continuous**: Adjust the white balance continuously.

It is recommended to correct white balance when there is great difference between the device's color effect and actual effect. You can correct white balance as shown below.

Auto Correction

Steps

1. Put a white paper in the range of the device's field of view, and make sure the paper covers the entire field of view.
2. Set exposure and gain.

Note

It is recommended to set image pixel value between 120 and 160.

3. Select **Wide** as **AWB Color Temperature Mode** to let the device adjust white balance again if the image's color effect is not good under the default condition of **Balance White Auto** is **Continuous** and **AWB Color Temperature Mode** is **Narrow**.

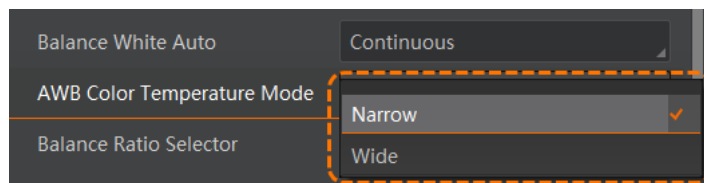

Figure 11-24 Set AWB Color Temperature Mode

Manual Correction

If there is still great difference between correction effect and actual color, it is recommended to manually correct white balance according to following steps.

Steps

Note

- For specific **Balance Ratio Selector** value, please refer to the actual condition.
- In order to avoid repeated correction after restarting the device, it is recommended to save white balance parameter to **User Set** after white balance correction. You can refer to the section [Save User Set](#) and [Load User Set](#) for details.

- If the light source and color temperature change, you need to correct white balance again.
- If the pixel format is Bayer, you can correct white balance via the white balance tool in the client software with 3.2.0 version and later. Refer to **Machine Vision Software User Manual** for details.

1. Select **Off** as **Balance White Auto**. At this time, **Balance Ratio** is 1024.
2. Find corresponding R/G/B channel in **Balance Ratio Selector**.
3. Find device's R/G/B value.
4. Take **Green** as correction standard, and manually adjust other two channels (R channel and B channel) to let these three channels have same value.

11.16 Set Sequencer

If the device supports sequencer, you can configure multiple groups of parameters including exposure time and gain. The principle of the sequencer is shown below.

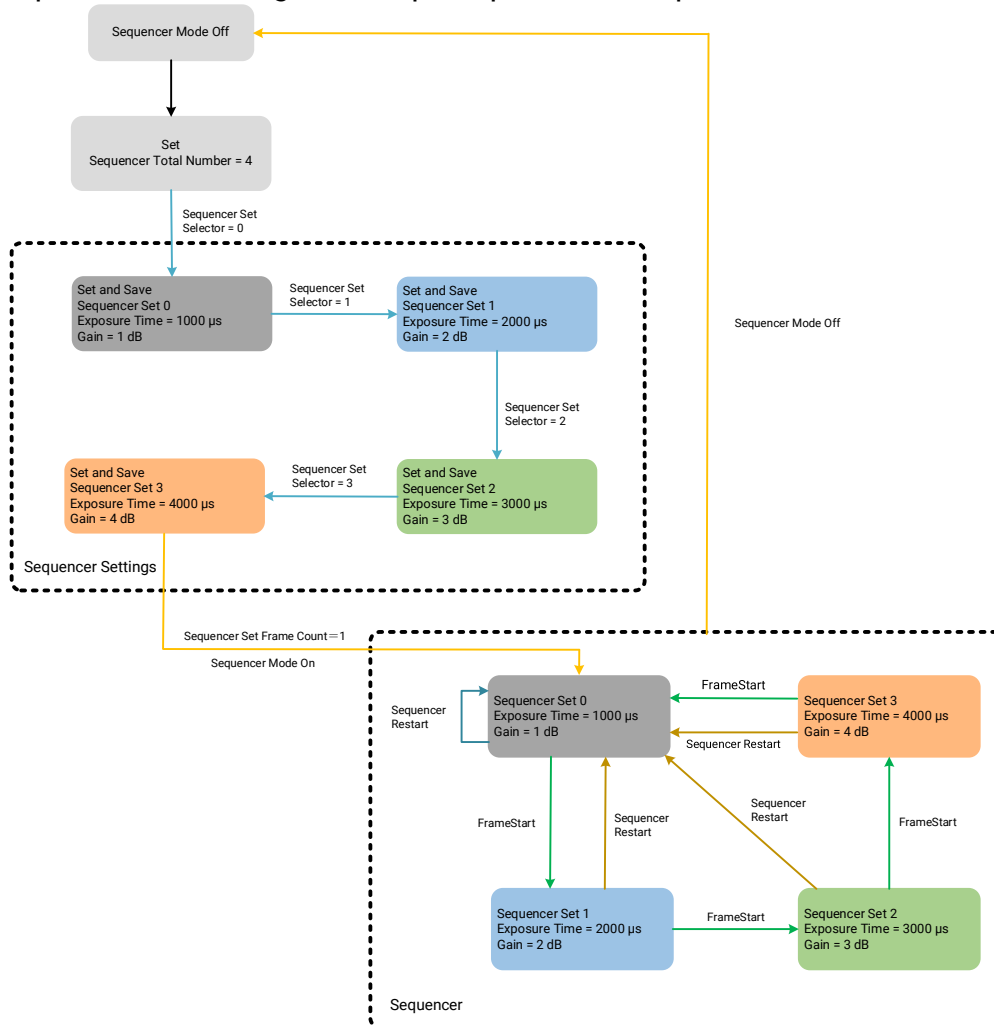

Figure 11-25 Principle of Sequencer

Note

You cannot configure parameters like trigger width, exposure time mode during sequencer.

Steps

1. Go to **Sequencer Control**, select **Off** as **Sequencer Mode**, and **On** as **Sequencer Configuration Mode**.

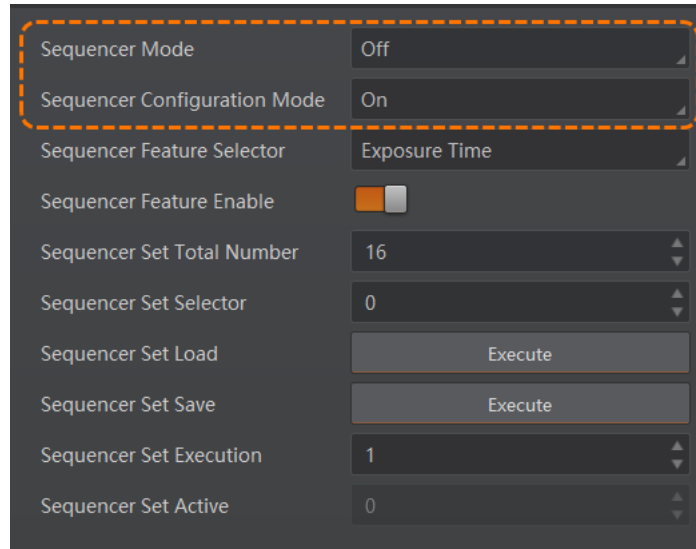

Figure 11-26 Set Sequencer Control

2. Set **Sequencer Set Total Number** to configure the number of groups to join sequencer according to actual demands.
3. Set **Sequencer Set Selector** to select one group of parameters, and set **Sequencer Feature Selector** to configure specific parameters.

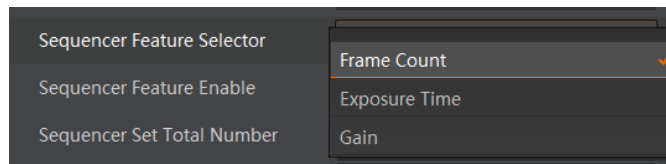

Figure 11-27 Sequencer Feature Selector

Note

- You should go to the corresponding parameters to set their detailed parameters.
- **Sequencer Feature Enable** is enabled by default for configured parameters.

4. You can set the number of sequencer executions for the selected groups in **Sequencer Set Frame Count**.
5. (Optional) Click **Execute** in **Sequencer Set Load** to load selected parameters in **Sequencer Set Selector**.
6. Click **Execute** in **Sequencer Set Save** to save the selected group of parameters.

- 7. Repeat step 3 to step 6 to configure other groups of parameters.
 - 8. Select **On** as **Sequencer Mode** to start sequencer after configuration.
-

Note

You cannot configure detailed parameters of group of parameters once sequencer is started.

- 9. (Optional) Click **Execute** in **Sequencer Restart** to let the sequencer start from the beginning group.
-

Note

The **Sequencer Restart** is valid when **Sequencer Mode** is **On**.

11.17 User Set Customization

This function allows you to save or load device settings. The device supports four sets of parameters, including one default set and three user sets, and the relation among four sets of parameters is shown below.

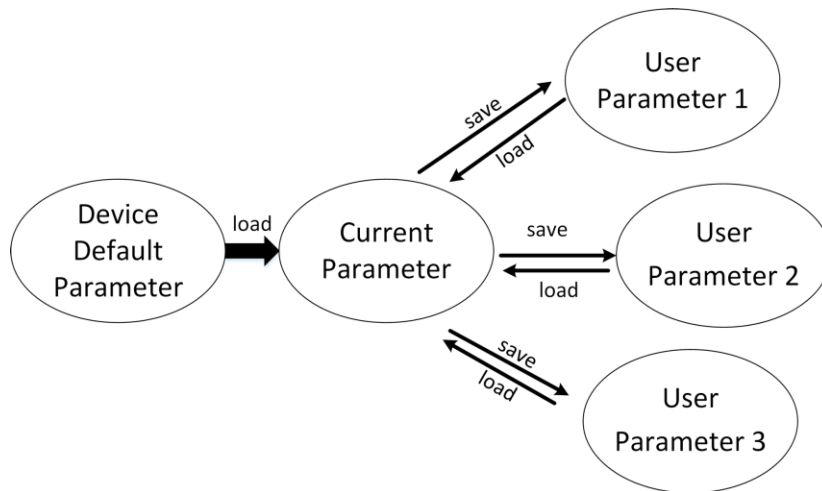

Figure 11-28Parameter Relation

Note

After setting user parameters, it is recommended to save user parameters and select them as the default parameters.

11.17.1 Save User Set

Steps

- 1. Go to **User Set Control**, and select a user set in **User Set Selector**.
-

Note

Here we take selecting **User Set 1** as an example.

2. Click **Execute** in **User Set Save** to save parameter.
3. View **User Set Save Status**:
 - Saving: User parameters are being saved.
 - Ready: User parameters have been saved.

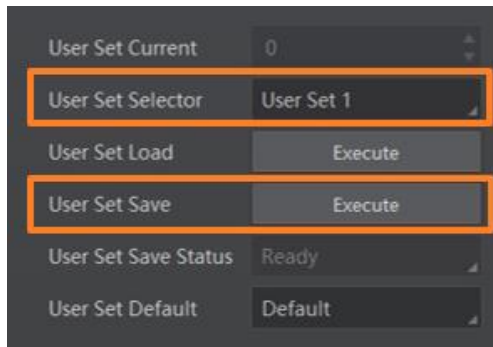

Figure 11-29 Save User Set

11.17.2 Load User Set

Note

Loading user set is available only when the device is connected but without live view.

Steps

1. Go to **User Set Control**, and select a user set in **User Set Selector**.
-

Note

Here we take selecting **User Set 1** as an example.

2. Click **Execute** in **User Set Load** to load parameter.

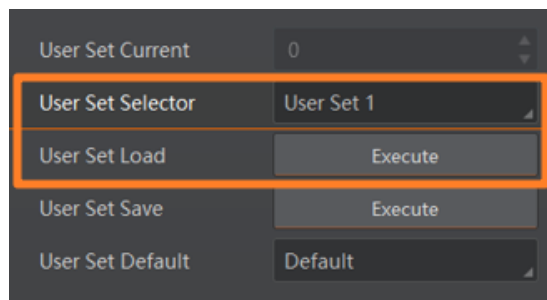

Figure 11-30 Load User Set

11.17.3 Set User Default

You can also set default parameter by going to **User Set Control** and selecting a user set in **User Set Default**.

 **Note**

- The User Set Default is the user set that will be loaded upon power cycling the camera
 - Here we take selecting **User Set 1** as an example.
-

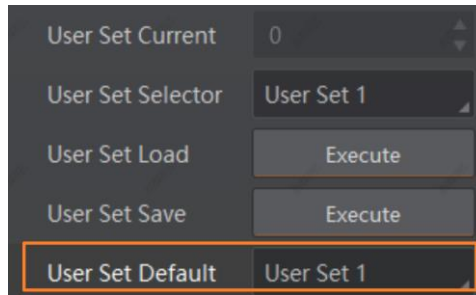

Figure 11-31 Set User Default

Chapter 12 Advanced Functions

12.1 Set Sensor Mode

Note

The sensor mode function may differ by device models.

The device provides two types of sensor mode, including high full well capacity and high sensitivity.

Go to **Analog Control** → **Sensor Mode**, and select **Sensor Mode** according to actual demands.

- **High Full Well Capacity**: It provides a higher dynamic range, enhancing image clarity and reducing noise. It is applicable for the environment with low illumination.
- **High Sensitivity**: It improves the image's sensitivity. In this mode, the device provides better photosensitivity performance and the brighter image.

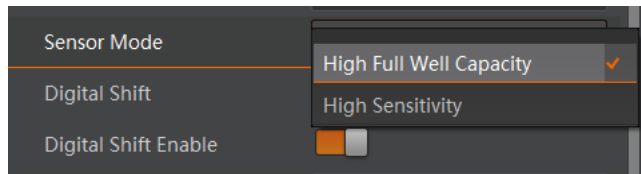

Figure 12-1 Set Sensor Mode

12.2 Set Black Level

Note

The default value of black level may differ by device models.

The black level function can adjust the gray value offset of the output data, determining the average gray value when the sensor is not exposed to light.

Go to **Analog Control** → **Black Level Enable**, enable **Black Level Enable**, and enter **Black Level** according to actual demands.

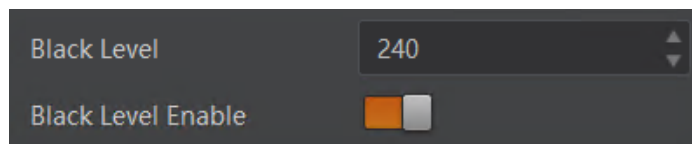

Figure 12-2 Set Black Level

12.3 Set Gamma Correction

Note

- The Gamma correction function may differ by device models or pixel formats.
- The Gamma correction function is not supported in Bayer format for color device.
- The Gamma correction function is disabled by default.

The device supports Gamma correction function. Generally, the output of the device's sensor is linear with the photons that are illuminated on the photosensitive surface of the sensor. Gamma correction provides a non-linear mapping mechanism as shown below.

- Gamma between 0.5 and 1: image brightness increases, dark area becomes brighter.
- Gamma between 1 and 4: image brightness decreases, dark area becomes darker.

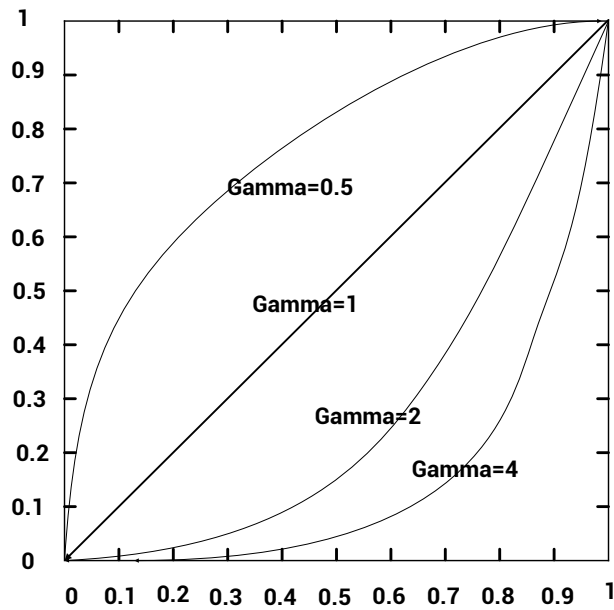

Figure 12-3 Set Gamma Correction

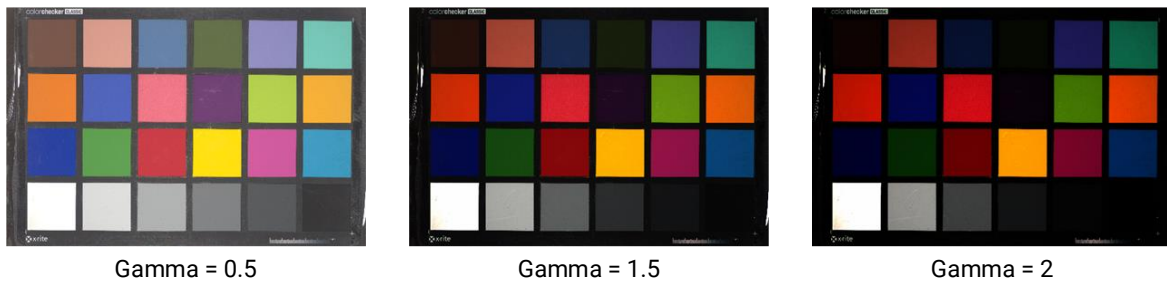

Figure 12-4 Gamma Correction Example

There are 2 types of Gamma correction, including **User** mode and **sRGB** mode. Settings

method is different as shown below.

User Mode

Steps

1. Go to **Analog Control** → **Gamma Selector**.
2. Select **User** as **Gamma Selector**.
3. Enable **Gamma Enable** to enable it.
4. Enter **Gamma** according to actual demands.

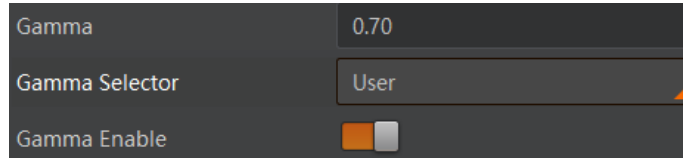

Figure 12-5 Set User Mode

sRGB Mode

Steps

1. Go to **Analog Control** → **Gamma Selector**.
2. Select **sRGB** as **Gamma Selector**.
3. Enable **Gamma Enable** to enable it.

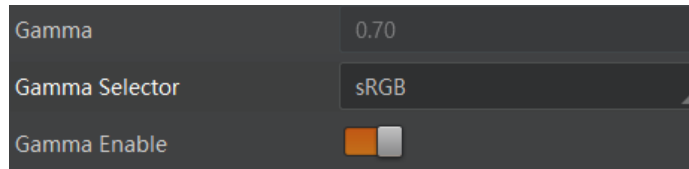

Figure 12-6 Set sRGB Mode

12.4 Set Digital Noise Reduction

The function of digital noise reduction can increase the image's SNR and improve its quality.

Steps

1. Go to **Analog Control** → **Digital Noise Reduction Mode**.
2. Select **Expert** as **Digital Noise Reduction Mode**. **Off** means that this function is disabled.
3. Enter **Denoise Strength** and **Noise Correct** according to actual demands.
 - **Denoise Strength** refers to the noise reduction intensity, and you can increase it to have a better effect.
 - **Noise Correct** refers to the noise correction value, and it is used to adjust the standard

deviation of the noise curve to match the real image, enhancing the ability to distinguish between noise and image texture. You can set this value according to the real scenarios.

12.5 Set AOI

Note

- AOI 1 is used to adjust the brightness when the device is in once or continuous exposure mode, and AOI 2 is used to adjust the white balance when the color device is in once or continuous white balance mode.
 - The AOI function is not supported when rotation function is enabled. Refer to section [Set Rotation](#) for details.
-

The device supports AOI function that can adjust the brightness and white balance of the entire image based on the area you selected.

Steps

1. Click **Analog Control** → **Auto Function AOI Selector**, and select **AOI 1** or **AOI 2**.
2. Enter **Auto Function AOI Width**, **Auto Function AOI Height**, **Auto Function AOI Offset X**, and **Auto Function AOI Offset Y** according to actual demands.
3. Enable **Auto Function AOI Usage Intensity** if **AOI 1** is selected as **Auto Function AOI Selector**. Or enable **Auto Function AOI Usage White Balance** if **AOI 2** is selected as **Auto Function AOI Selector**.

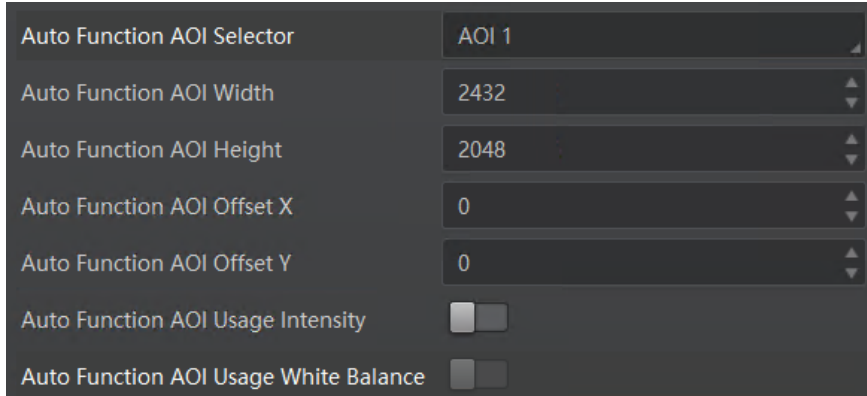

Figure 12-7 Set AOI

12.6 Set CCM

Note

The function of CCM is only available for color devices.

After the image is processed by the white balance, the overall image will be dark, and at

the same time, various colors may deviate from their standard values to varying degrees. At this time, it is necessary to multiply the color of the image by the correction matrix to correct each color to its standard value, so that the overall color of the image is more vivid. The CCM function is implemented by multiplying each RGB component by a correction matrix. The currently supported color conversion module is RGB to RGB.

Note

- The CCM function is valid in RGB and YUV pixel formats.
 - Regarding the color device in Bayer pixel format, you need to enable Super Bayer Enable first before using CCM function.
-

Two methods are available to set CCM function.

• Method 1:

Steps

1. Go to **Color Transformation Control**, and enable **CCM Enable**.
2. Select parameter in **Color Transformation Value Selector**, and set **Color Transformation Value** according to actual demand.

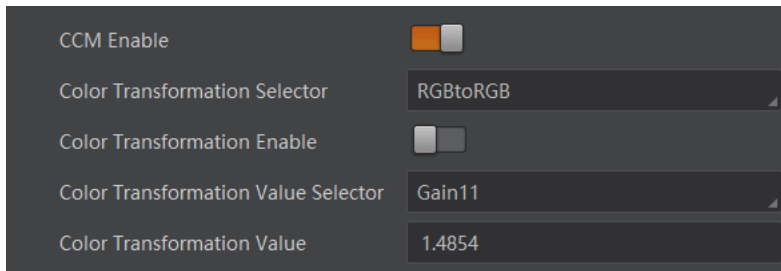

Figure 12-8 Method 1

• Method 2:

Go to **Color Transformation Control**, enable **Color Transformation Enable**, set **Hue** and **Saturation** to adjust **Color Transformation Value**.

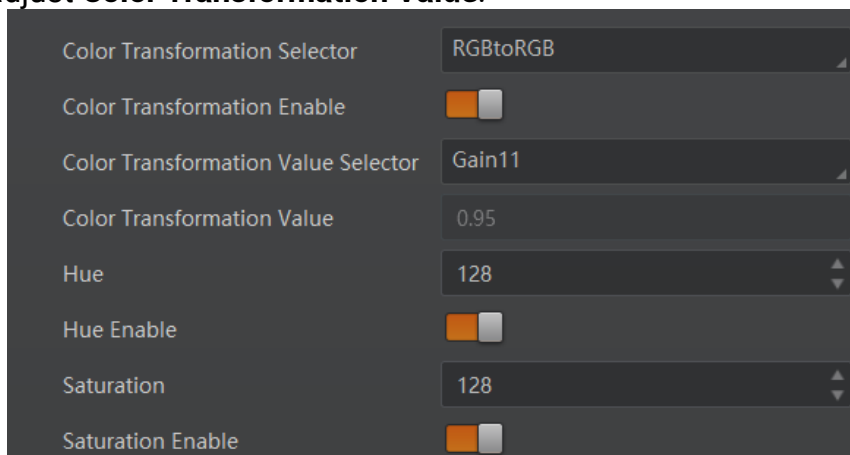

Figure 12-9 Method 2

Note

- **CCM Enable** is used to enable CCM function. If the device you purchased does not have **CCM Enable**, then the CCM function is enabled by default.
- The CCM function is achieved by adjusting the values of the parameters in **Color Transformation Value Selector**, where Gain00, Gain10, and Gain20 adjust the R component of the red pixel, Gain01, Gain11, and Gain21 adjust the G component of the green pixel, and Gain02, Gain12, and Gain22 adjust the B component of the blue pixel.

12.6.1 Set Hue

Note

- The hue function is only available for color devices.
- In Mono pixel format, hue function is not supported.
- The range of hue is between 0 and 255.

Adjusting the hue shifts the colors of the image. After hue is set, the device will perform CCM function based on the hue value to bring the image tone to the target value. For example, when hue is set to 128, the red in the image appears as real red. When hue is 0, the hue is reversed 128 degrees counterclockwise, and red becomes blue. When hue is 255, the hue rotates 128 degrees clockwise, and red becomes green. Image examples of different hue values are shown below.



Figure 12-10 Hue Example

Before You Start

Make sure the **Pixel Format** of the color device is **Bayer**, **YUV**, **RGB**, or **BGR**.

Steps

1. Go to **Color Transformation Control**, and enable **Hue Enable**.
2. Enter **Hue** according to actual demands.

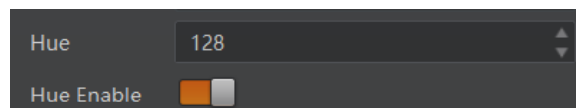

Figure 12-11 Set Hue

Note

It is not recommended to edit the default values. If you have any questions, please contact technical support.

12.6.2 Set Saturation

Note

- The saturation function is only available for color devices.
- In Mono pixel format, saturation function is not supported.
- The range of saturation is between 0 and 255.

Adjusting the saturation changes the colorfulness of the colors. A higher saturation, for example, makes colors easier to distinguish. Image examples of different saturation values are shown below.

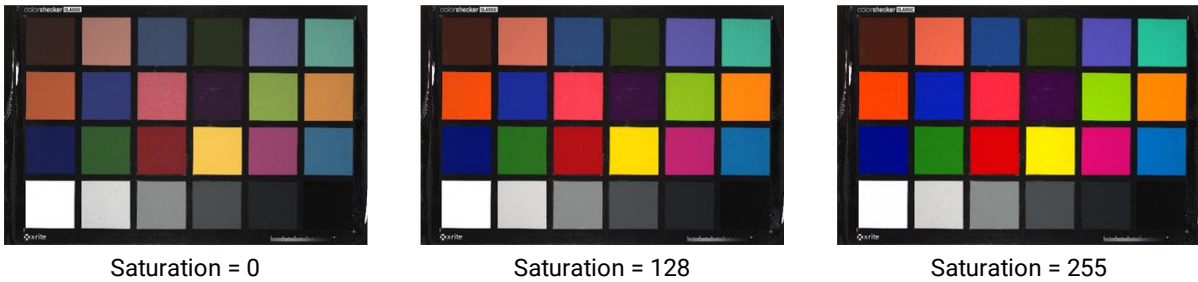

Figure 12-12 Saturation Example

Before You Start

Make sure the **Pixel Format** of the color device is **Bayer**, **YUV**, **RGB**, or **BGR**.

Steps

1. Go to **Color Transformation Control**, and enable **Saturation Enable**.
2. Enter **Saturation** according to actual demands.

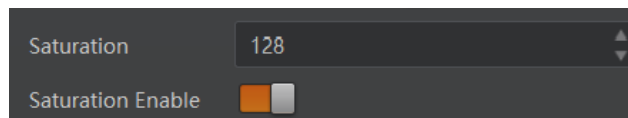

Figure 12-13 Set Saturation

12.7 Set Super Palette Control

Note

- Regarding the color device in Bayer pixel format, you need to enable **Super Bayer Enable** first before using super palette control function.
 - The super palette control function is valid in RGB and YUV pixel formats.
-

The super palette control function allows you to select different color areas in the image to set customized hue and saturation values.

Steps

1. Go to **Super Palette Control**, and enable **Super Palette Enable**.
2. Select **Super Palette Selector**.

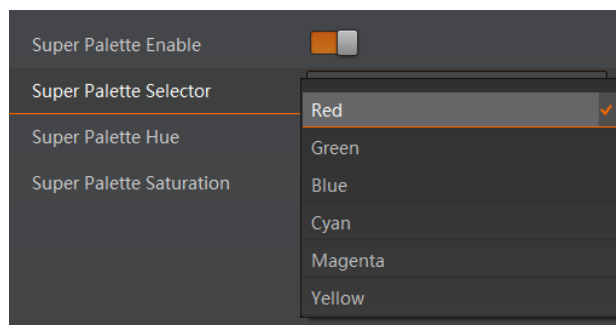

Figure 12-14 Super Palette Selector

3. Set corresponding **Super Palette Hue** and **Super Palette Saturation** according to actual demands.

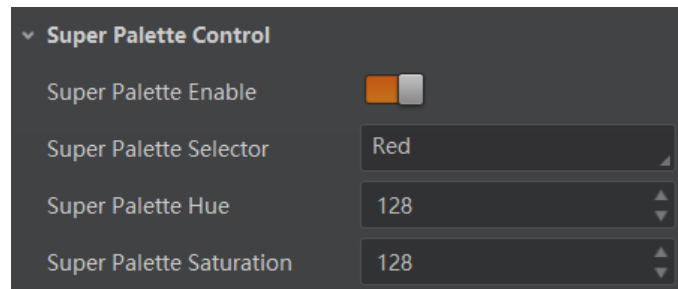

Figure 12-15 Set Super Palette Control

12.8 Set Automatic Color Correction

Automatic color correction, based on a multi-spectral fusion technology, can achieve one-click camera color adjustment. This function automatically adjusts parameters such as white balance, CCM, super palette, and Gamma functions, simplifying the steps of manual correction under different lighting conditions. Additionally, it addresses color reproduction

issues in large-area scenes with non-neutral pure color, enhancing the accuracy of color reproduction.

Note

- The automatic color correction function is valid in RGB and YUV pixel formats.
 - Regarding the color device in Bayer pixel format, you need to enable Super Bayer Enable first before using automatic color correction function.
-

Before You Start

For the optimal correction results, place a white paper that completely covers and extends beyond the device's field of view, and perform the auto correction. After correction is finished, remove the paper and capture the target object.

Steps

1. Go to **Analog Control** → **Color Correction Selector**, and select a calibration file used for automatic color correction. **Factory** or **User** can be selected.
 - **Factory:** It refers to the factory-default calibration file.
 - **User:** It refers to the user-imported calibration file.
-

Note

Refer to section [File Access Control](#) to import files of Color Profile User and Spectrum Profile User.

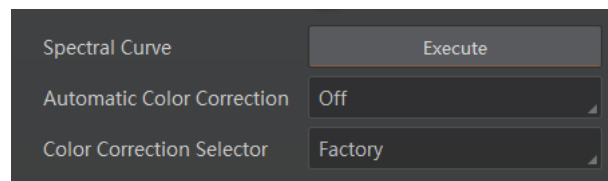

Figure 12-16 Set Automatic Color Correction

2. Select **Once** in **Automatic Color Correction**, and the device will execute automatic color correction once to adjust parameters such as white balance, CCM, super palette, and Gamma functions under different lighting conditions.
 3. (Optional) If inaccurate white color is observed after automatic color correction, you should perform automatic white balance to correct the deviation. Refer to section [Set White Balance](#) for details.
 4. (Optional) Click **Execute** in **Spectral Curve** to automatically get the spectral curve based on the light source via the File Access function.
- Image examples of automatic color correction under different lighting conditions are

shown below.

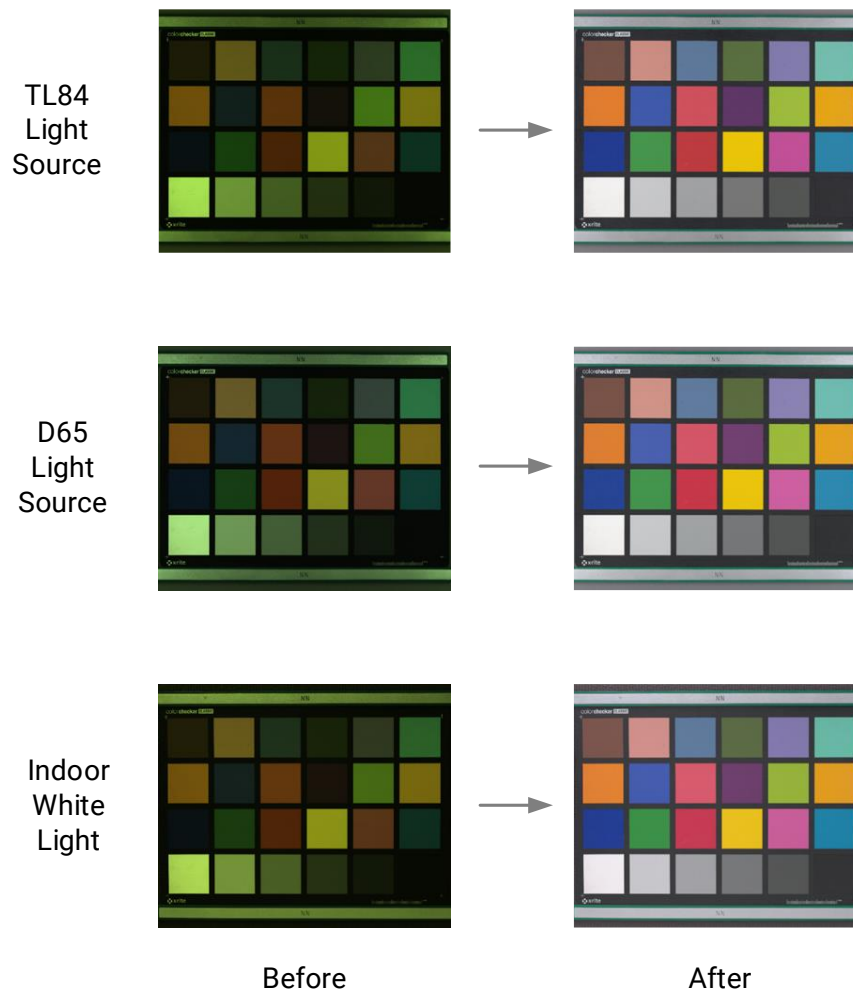

Figure 12-17 Automatic Color Correction Example

12.9 Set LUT

A Look-Up Table (LUT) is a customizable grayscale-mapping table. You can stretch and amplify the grayscale range. The mapping can be linear or customized curve.

Note

- You cannot use Gamma correction function and LUT function at the same time.
 - The parameter of **LUT Save** may differ by device models. If the device has no **LUT Save**, the settings you configured will be saved in the device in real time.
 - For different LUTs, after you set **LUT Index** and **LUT Value**, you should click **Execute** in **LUT Save** respectively.
 - The LUT function is not supported for the color device in Bayer format.
-

Steps

1. Click **LUT Control**, and enable **LUT Enable**.
2. Select one group in the **LUT Selector**.
2. Enter **LUT Index** and **LUT Value** according to actual demands.
3. Click **Execute** in **LUT Save** to save it.

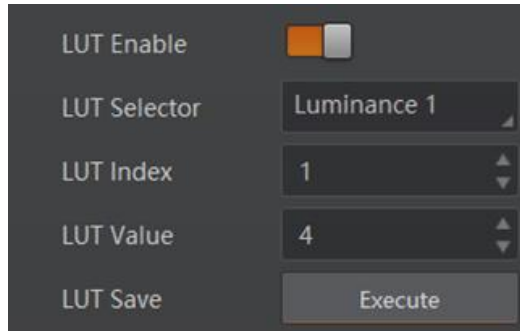

Figure 12-18Set LUT

12.10 Set CLUT

A Color Look-Up Table (CLUT) is a 3D color mapping table that transforms the original RGB values into target RGB values through color mapping. This function supports adjustment of brightness, saturation, and hue. You can import a calibrated CLUT to adjust specific colors while keeping other colors unaffected.

Steps

1. Go to MVS client software, and open ISP Tool to get the calibrated CLUT.

 **Note**

Refer to *ISP Tool User Manual* for details.

2. Import the calibrated CLUT in **File Access**. Refer to section [File Access Control](#) for details.
3. Enable **CLUT Enable** in **LUT Control**.

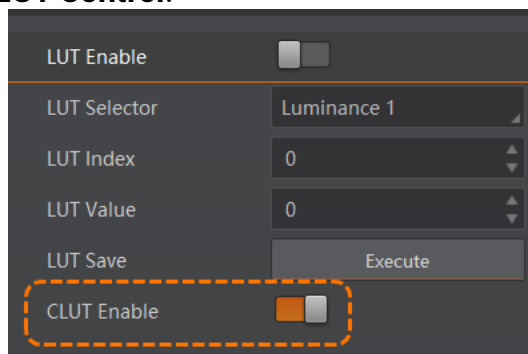

Figure 12-19Set CLUT

12.11 Set LSC Correction

LSC correction stands for Lens Shading Correction that eliminates non-uniform illumination brought by lens. The images before LSC correction and after correction are shown below.

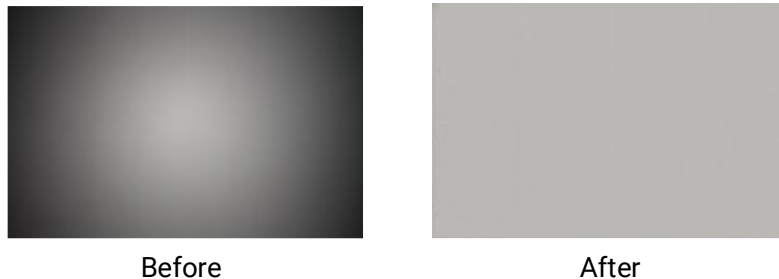

Figure 12-20 LSC Correction

Steps

1. Go to **Shading Correction**, and select **LSC Correction** as **Shading Selector**.
2. Select **Brightest** or **Setting Value** in **LSC Calib Select** to calculate the data.
 - **Brightest**: Use the brightest area in the image as a reference to calculate brightness differences of other areas, and then correct the other parts of the image based on the calculated brightness differences.
 - **Setting Value**: You can customize the brightness value, and then the current image will be corrected to match the set brightness value. After selecting **Setting Value**, you can set the effective brightness via **LSC Target Gray**.
3. Enable **LSC Enable**.

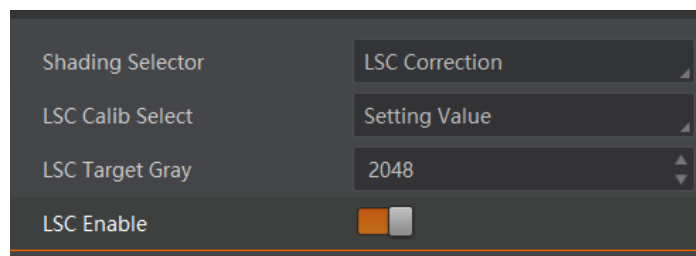

Figure 12-21 Set LSC Correction

4. After the device starts image acquisition, you can click **Execute** in **Activate Shading** to let the client software automatically calculate the data

Note

- LSC correction should be executed in full resolution. If you are only interested in a certain region of the image, you can set a Region of Interest (ROI) after correction.
 - If the light source and color temperature change, you need to execute LSC correction again.
-

12.12 Set PFC

Purple fringing correction (PFC) can address an issue of chromatic aberration in an image. It corrects the purple or red edge caused by lens refraction and lighting condition, effectively enhancing color fidelity and image clarity. Image examples of PFC are shown below.

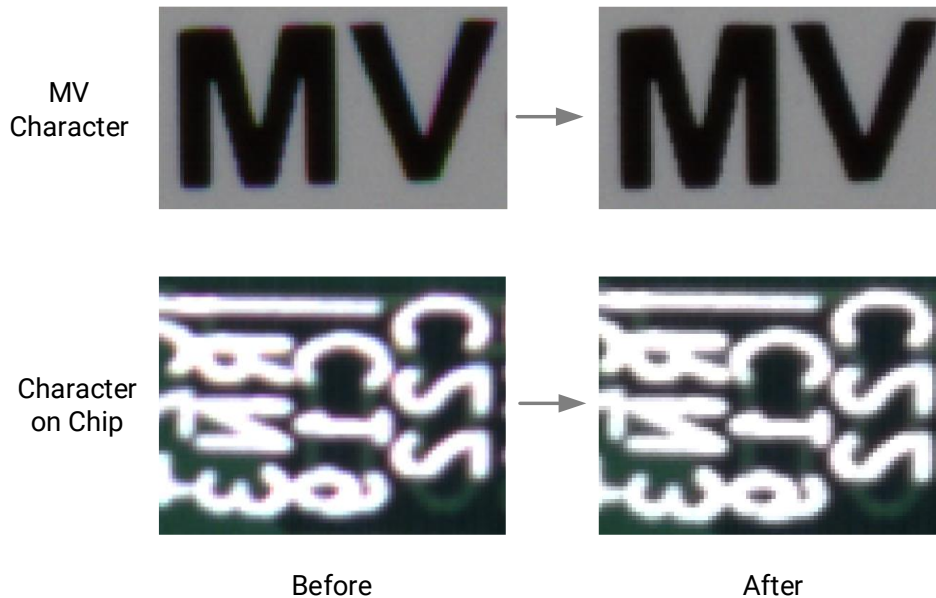

Figure 12-22 PFC Example

Note

- The PFC function may differ by device models.
 - Regarding the color device in Bayer pixel format, you need to enable **Super Bayer Enable** first before using PFC function.
 - The PFC function is valid in RGB and YUV pixel formats.
-

Steps

1. Go to **Shading Correction**, and enable **PFC Enable**.
2. Set related parameters shown below.
 - **PFC Window Size**: It sets filter kernel size of PFC. Generally, the thicker the purple edge, the higher the value needs to be set, achieving a significant correction effect.
 - **PFC Edge Threshold**: It used to identify edge point on the image. The smaller the value, the more pixels are identified as edges, and the more texture edges will be processed by PFC.

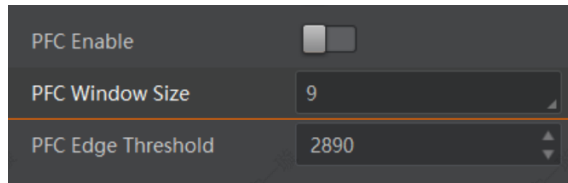

Figure 12-23 Set PFC

12.13 Set Heat Balance

After the devices are powered on, heat generated by internal components causes a gradual temperature rise until it stabilizes at a constant value. The performance of the device sensor is sensitive to temperature changes. To ensure rapid optimal imaging after startup, the devices with PRO version and MAX version are equipped with a precise temperature control system to achieve fast heat balance. This function significantly reduces the time required for the sensor to reach a stable operating temperature.

Heat Balance Test

You need to get the temperature of sensor board via heat balance test before the heat balance function is enabled.

Before You Start

Make sure that the device is connected, and **Temperature Balance** in **Device Control** is disabled.

Steps

1. Go to **Device Control** → **Device Temperature Selector**, and select **Sensorboard**.

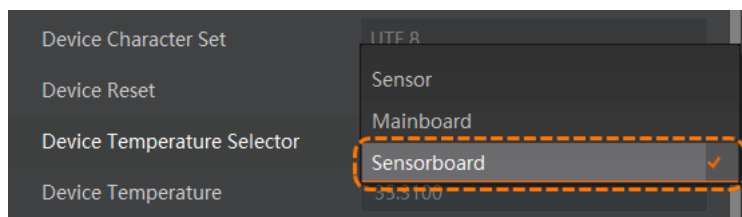

Figure 12-24 Select Sensor Board

2. Run the device according to the actual needs until the temperature of sensor board displayed in **Device Temperature** does not change over time, and then record this temperature value.

Note

- When performing the heat balance test, make sure that heat dissipation factors, such as environment temperature, device installation method, and operating frame rate, should be consistent with the conditions used when the fast heat balance function is enabled.

This prevents temperature deviation due to different conditions.

- It is recommended to operate the heat balance test for at least 60 minutes until the value in **Device Temperature** stabilizes to achieve heat balance.
-

Fast Heat Balance Settings

Before You Start

The temperature of sensor board is obtained via heat balance test.

Steps

1. Go to **Device Control** → **Temperature Balance**, and enable this function.
2. Set **Target Temperature**. The value is equal to the sensor board temperature obtained from the heat balance test plus 5 °C.
3. Run the device, and the sensor board temperature displayed in **Device Temperature** will quickly rise to the target temperature.

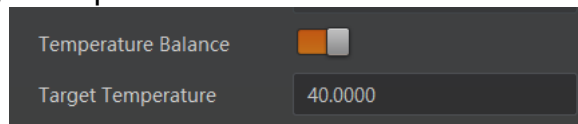

Figure 12-25Fast Heat Balance

Note

- To achieve fast heat balance, the environment temperature variations should be minimized. During the fast heat balance process, maintain the device's environment temperature within ± 5 °C of the temperature recorded in the heat balance test.
 - The target temperature should be between 20 °C and 75 °C. Due to sensor temperature rise (5 °C to 30 °C), this function has limits of environment temperature. If the environment temperature is higher than 40 °C, the target temperature may exceed 75 °C, or if environment temperature is lower than 10 °C, target temperature may fall below 20 °C. Therefore, it is recommended to use this function within the environment temperature range of 10 °C to 40 °C.
 - When the fast heat balance function is enabled, the max. power consumption of the device will increase, typically adding no more than 5 W to the base power consumption. Please make sure that the power supply can meet this peak requirement.
-

12.14 Set Event Control

Note

The specific events may differ by device models.

The event control can record events and allow you to view them.

Steps

1. Go to **Event Control** → **Event Selector**, and select an event source in **Event Selector** according to actual demands.

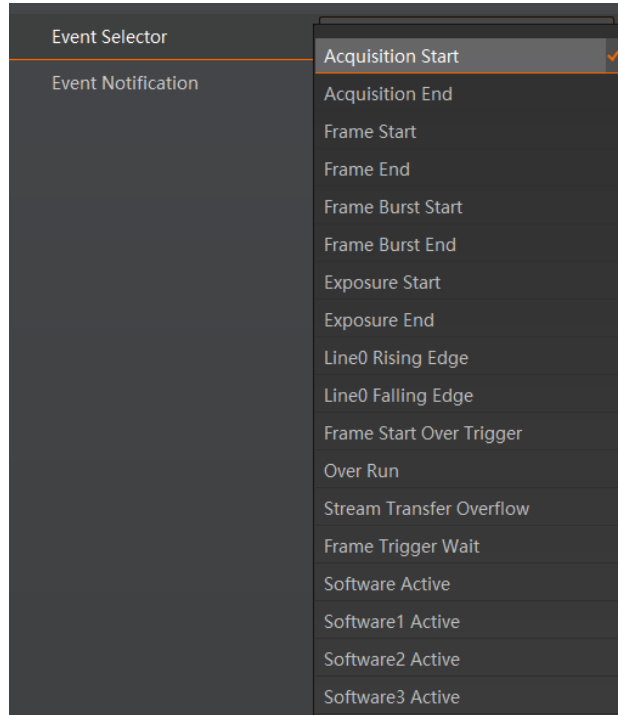

Figure 12-26 Event Selector

2. Select **Notification On** as **Event Notification** to output event.

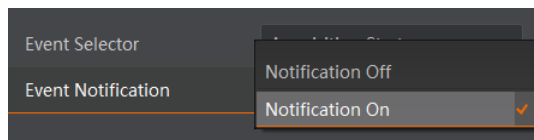

Figure 12-27 Set Event Control

3. Right click the connected device and click **Event Monitor**.

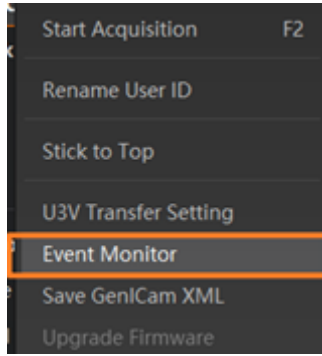

Figure 12-28 Event Monitor

4. Check **Messaging Channel Event**, and view the specific event after the device starts live view.

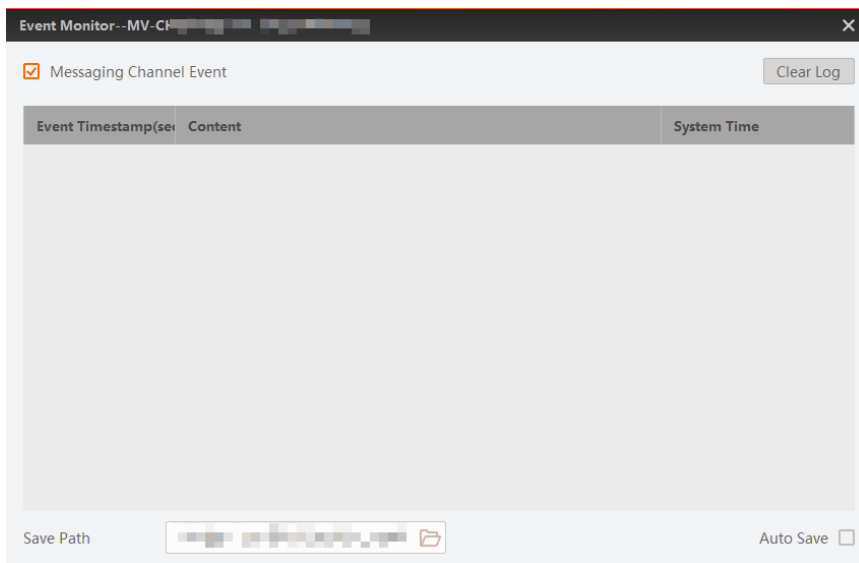





Figure 12-29 Event Monitor Window

12.15 Set Transfer Control

You can go to **Transfer Control** to view the device’s transfer sources, transfer mode, queue information, etc. The parameters of transfer control are shown below.

Table 12-1 Parameters of User Controlled Transfer Control

Parameter	Read/Write	Description
Transfer Selector	Read & Write	Only Stream 0 can be selected. ⓘ Note This parameter is valid when Image Compression Mode is HB or JPEG .

Parameter	Read/Write	Description
Transfer Control Mode	Read & Write	<p>It selects the transfer mode.</p> <ul style="list-style-type: none"> ● Basic: In this mode, the device sends images to the client software directly after acquiring images. ● UserControlled: In this mode, the device saves images in its internal cache first, and then sends to the client software after acquiring images.
Transfer Passive Enable	Read & Write	<p>The transfer passive node will be displayed if it is enabled.</p> <p> Note</p> <ul style="list-style-type: none"> ● You should select UserControlled as Transfer Control Mode first. ● Make sure that the device's Trigger Mode is On.
Transfer Operation Mode	Read & Write	<p>It is the transfer operation mode:</p> <ul style="list-style-type: none"> ● Single Block: Click Execute in Transfer Start to let the device transfer one image each time. ● Multi Block: Click Execute in Transfer Start to let the device transfer multiple images in cache. <p> Note</p> <p>You should select UserControlled as Transfer Control Mode first, and enable Transfer Passive Enable.</p>
Transfer Queue Max Block Count	Read Only	<p>It displays the max. image quantity that the device's memory can save before the compression.</p>
Transfer Queue Current Block Count	Read Only	<p>It displays current image quantity saved by the memory.</p>
Transfer Queue Over Flow Count	Read Only	<p>It displays the number of images overwritten in memory, which is the quantity discarded by the FPGA after compression.</p>
Transfer Queue Mode	Read & Write	<p>It sets memory queue working mode. Only First In First Out can be selected.</p>
Transfer Start	Read & Write	<p>Click Execute to let the device transfer images.</p> <p> Note</p> <p>It will be displayed when UserControlled is selected as Transfer Control Selector and image acquisition is started.</p>

Chapter 13 Other Functions

13.1 Device Control

Note

The specific device control parameters may differ by device models.

In **Device Control**, you can view device information, edit device name, reset device, etc. The specific parameters in **Device Control** are shown below.

Table 13-1 Parameters of Device Control

Parameter	Read/Write	Description
Device Scan Type	Read Only	It is the scan type of the device's sensor.
Device Vendor Name	Read Only	It is the name of the manufacturer of the device.
Device Model Name	Read Only	It is the model of the device.
Device Manufacturer Info	Read Only	It is the manufacturer information about the device.
Device Firmware Version	Read Only	It is the device firmware version.
Device Serial Number	Read Only	It is device's serial number.
Device User ID	Read & Write	It is the device name and is empty by default. You can set according to your preference. <ul style="list-style-type: none"> • If User ID is empty, the client software displays the device model. • If you set it, the client software displays the User ID you set.
Maximum Device Response Time	Read Only	It is the device max. response time. If it has no response after this time, the device is disconnected.
Device Manifest Table Address	Read Only	It is the ID of GenICam XML that the device selects.
Device SBRM Address	Read Only	It is the base address register.
Device Timestamp	Read Only	It is the device timestamp.
Device Timestamp Latch	Read & Write	Click Execute to get the device

CT Series USB 3.0 Area Scan Camera User Manual

Parameter	Read/Write	Description
		timestamp.
Device Timestamp Increment	Read Only	It is the max. value of the device timestamp.
Device Protocol Endianness	Read Only	It is the device protocol endianness.
Device Implementation Endianness	Read Only	It is the device operating endianness.
Device Uptime (s)	Read Only	It is the period of time when device is powered up.
Board Device Type	Read Only	It is the device type.
USB Interface Selector	Read & Write	You can select the main or sub USB interface for data transmission.
USB Speed Mode	Read Only	It is the speed mode of USB interface, including High Speed (USB2.0) and Super Speed (USB3.0).
Device Link Throughput Limit Mode	Read & Write	It controls if the Device Link Throughput Limit is active. When disabled, lower level TL specific features are expected to control the throughput. When enabled, Device Link Throughput Limit controls the overall throughput.
Device Link Throughput Limit (Bps)	Read & Write	It limits the maximum bandwidth of the data that will be streamed out by the device on the selected link. If necessary, delays will be uniformly inserted between transport layer packets in order to control the peak bandwidth.
Device Link Current Throughput	Read Only	It is the current transmission bandwidth.
Device Stream Channel Count	Read Only	It indicates the number of streaming channels supported by the device.
Device Reset	Read & Write	Click Execute to reset the device.
Device Temperature Selector	Read & Write	It selects device sensor temperature.
Device Temperature	Read Only	It displays the temperature of the sensor.
Find Me	Read & Write	Click Execute to let red and blue indicators flash alternatively, and find device.

Parameter	Read/Write	Description
Device Max Throughput (bps)	Read Only	It is the maximum flow of device operation.
Device PJ Number	Read Only	It is the device's project number.
Temperature Balance	Read & Write	It is used to enable heat balance function. Refer to section Set Heat Balance for details.
Target Temperature	Read & Write	It sets a target temperature in heat balance function.
Device Standby Mode	Read & Write	<p>After it is enabled, the device will enter into standby mode. In this mode, the device stops image acquisition to reduce power consumption, but still supports ISP test image outputting and parameter settings.</p> <p> Note The mode settings apply globally. When it is enabled, loading device default parameters will not reset to default value.</p>

13.2 Transport Layer Control

You can go to **Transport Layer Control** to view the device's payload size, GenCP version, etc.

Note

The specific parameters of transport layer control may differ by device models.

Table 13-2 Parameters of Transport Layer Control

Parameter	Read/Write	Description
Payload Size	Read Only	It is the device's load size.
GenCP Version Major	Read Only	It is the major version in GenCP version.
GenCP Version Minor	Read Only	It is the minor version in GenCP version.
U3V Version Major	Read Only	It is the major version in U3V version.
U3V Version Minor	Read Only	It is the minor version in U3V version.
U3VCP SIRM Available	Read Only	It sets whether the device supports one flow interface at least.

Parameter	Read/Write	Description
U3VCP EIRM Available	Read Only	It sets whether the device supports one event interface at least.
U3VCP IIDC2 Available	Read Only	It sets whether the device supports IIDC2 register mapping.
U3V Max Command Transfer Length	Read Only	It is the device max. command transmission length.
U3V Max Acknowledge Transfer Length	Read Only	It is the device max. data transmission length.
U3V Number of Stream Channels	Read Only	It is the quantity of stream channel.
U3V SIRM Address	Read Only	It is the mapping address of SIRM.
U3V SIRM Length	Read Only	It is the length of each SIRM.
U3V EIRM Address	Read Only	It is the mapping address of EIRM.
U3V EIRM Length	Read Only	It is the length of each EIRM.
U3V Current Speed	Read Only	It is the current USB linking speed.

13.3 U3V Protocol Control

You can go to **Stream Control** to view USB transfer size, transfer times, final 1 value and final 2 value.

Note

The specific parameters of stream control may differ by device models.

Table 13-3 Parameters of Stream Control

Parameter	Read/Write	Description
U3V SI Payload Transfer Size	Read Only	It is the batch transmission size of stream data.
U3V SI Payload Transfer Count	Read Only	It is the batch transmission times of stream data.
U3V SI Payload FinalTransfer1 Size	Read Only	It is the Final 1 size of stream data.
U3V SI Payload FinalTransfer2 Size	Read Only	It is the Final 2 size of stream data.

13.4 Embedded Information

The device supports embedding information into image data. The information will be embedded into the image according to the enabling condition of each type of information in the order of the image embedding information listed in the table below.

Table 13-4 Image Embedding Information

Image Embedding Information	Byte	Data Format
Timestamp	4	Refer to the figure below this table.
Gain	4	The 4 bytes are used to transfer the gain information. Each low 8 bits of the 4 valid data are combined to transfer the gain information. Value Range: 0 to 1023. High bits will be complemented with 0 automatically.
Exposure	4	4 bytes are combined to show the exposure time, and the unit is μs .
Brightness Info	4	It ranges from 0 to 4095. High bits will be complemented with 0 automatically.
White Balance	8	R/G/B occupies 2 bytes each. Value Range: 0 to 4095. High bits will be complemented with 0 automatically.
Frame Counter	4	It ranges from 0 to $2^{32}-1$.
Ext Trigger Count	4	It ranges from 0 to $2^{32}-1$.
Line Input Output	4	The 1 st byte is input, and each bit corresponds to 1 input. The 2 nd byte is output, 3 rd and 4 th bytes are reserved.
Width	4	Ranges from 0 to $2^{32}-1$
Height	4	Ranges from 0 to $2^{32}-1$
Offset X	4	Ranges from 0 to $2^{32}-1$
Offset Y	4	Ranges from 0 to $2^{32}-1$
Pixel Format	4	Ranges from 0 to $2^{32}-1$

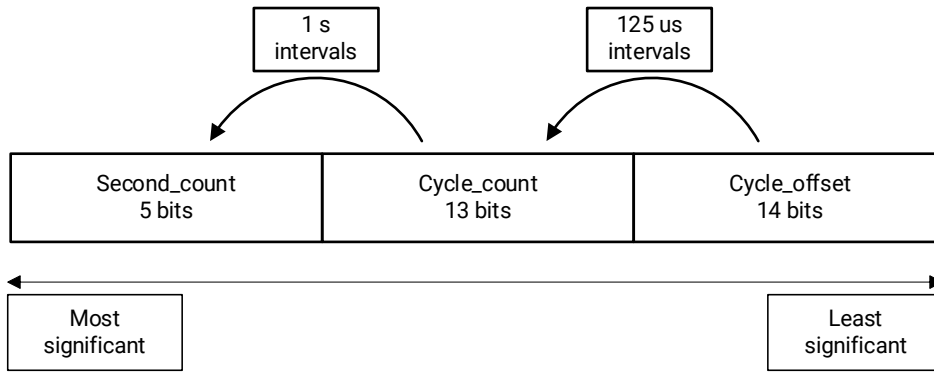

Figure 13-1 Data Format of Timestamp

Note

- The White Balance is only available for the color device.
- The Width, Height, Offset X, Offset Y, and Pixel Format are available for the device supports Chunk function.

You can go to Chunk Data Control to set related parameters.

Steps

1. Go to **Chunk Data Control** → **Chunk Mode Active**, and enable **Chunk Mode Active**.

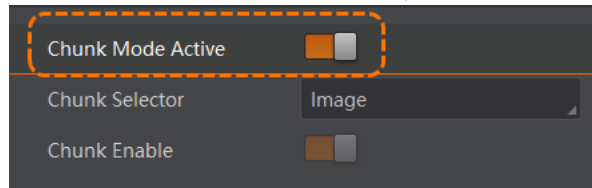

Figure 13-2 Enable Chunk Mode Active

2. Select **Chunk Selector** according to actual demands.

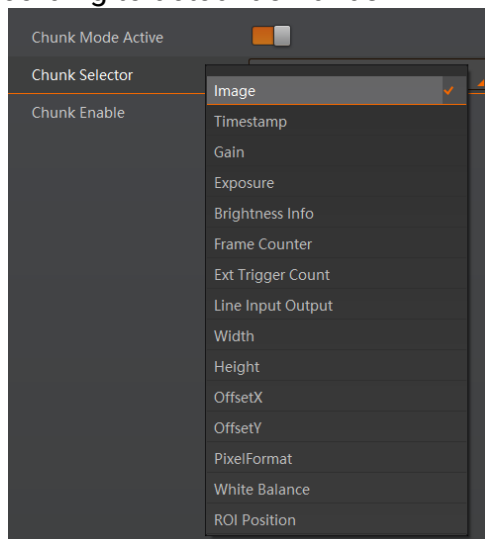

Figure 13-3 Select Embedded Image Information

3. Enable **Chunk Enable** to embed information into the image.

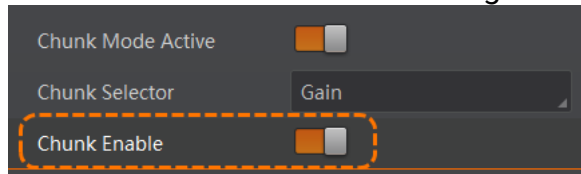



Figure 13-4 Chunk Enable

- 4. (Optional) Repeat steps above to add multiple Chunk information types.
- 5. Click  on the control toolbar of the client software to view specific information.

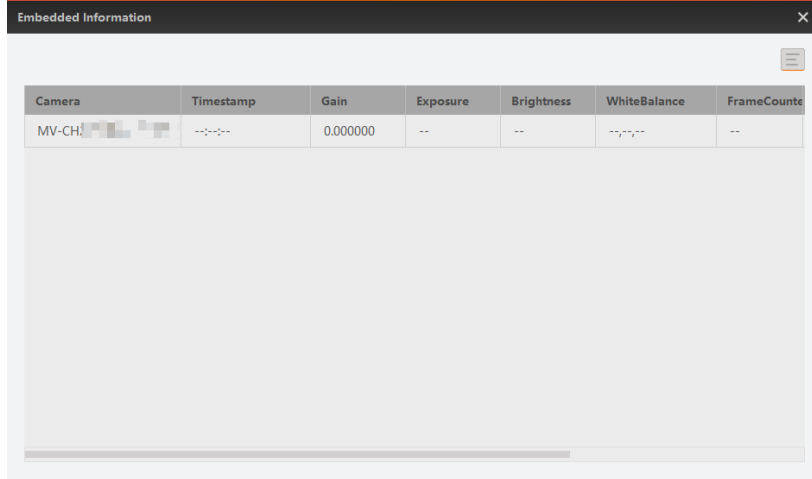

Figure 13-5 View Embedded Image Information

13.5 File Access Control

The file access function can import or export the device's feature files and save them in mfa format.

Steps

- 1. Select a device in the device list, and click  to open the file access dialogue box.



Figure 13-6 File Access

- 2. Select **Device Feature** and click **Import** or **Export**.

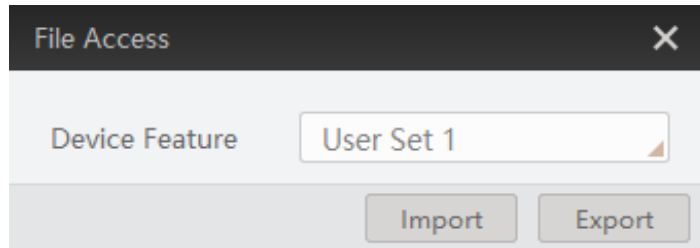

Figure 13-7 Import or Export

3. Select a file in MFA format from local PC to import, or select a saving path and enter file name to save and export.

Note

- Importing and exporting the device feature, DPC data, and LUT among the same model and same firmware of devices are supported.
 - If **User Set 1/2/3** is selected as device feature, you need to load the corresponding user set you selected to take effect.
 - If **DPC** or **CLUT** is selected as device feature, it will take effect immediately after importing. DPC means defective pixel data after calibration, and CLUT means color look-up table for calibration.
 - If **LUT Luminance 1/2/3** is selected as device feature, it will take effect only when you select the same parameters in LUT Selector.
 - **License Notice** and **Spectral Curv** support exporting only.
 - **Log File** supports exporting only.
 - **Color Profile User** and **Spectrum Profile User** support importing and exporting. They will take effect when you set **Once** as **Automatic Color Correction** after importing.
-

13.6 Update Firmware

You can use the MVS Tool Kit to update the device's firmware.

Note

The MVS Tool Kit is installed by default when you install the MVS client software.

Steps

1. Go to **Tool** → **Toolkit** → **Firmware Upgrade Tool** to open the MVS Tool Kit.
2. Select **Camera** in the **Select Type**. The tool will automatically refresh and show all enumerated devices.

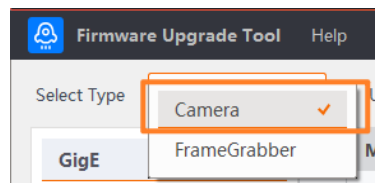



Figure 13-8 Select Camera

3. Select the device in available status to update.
4. Click  to select firmware upgrade package (dav file).
5. Click **Update** to start updating.

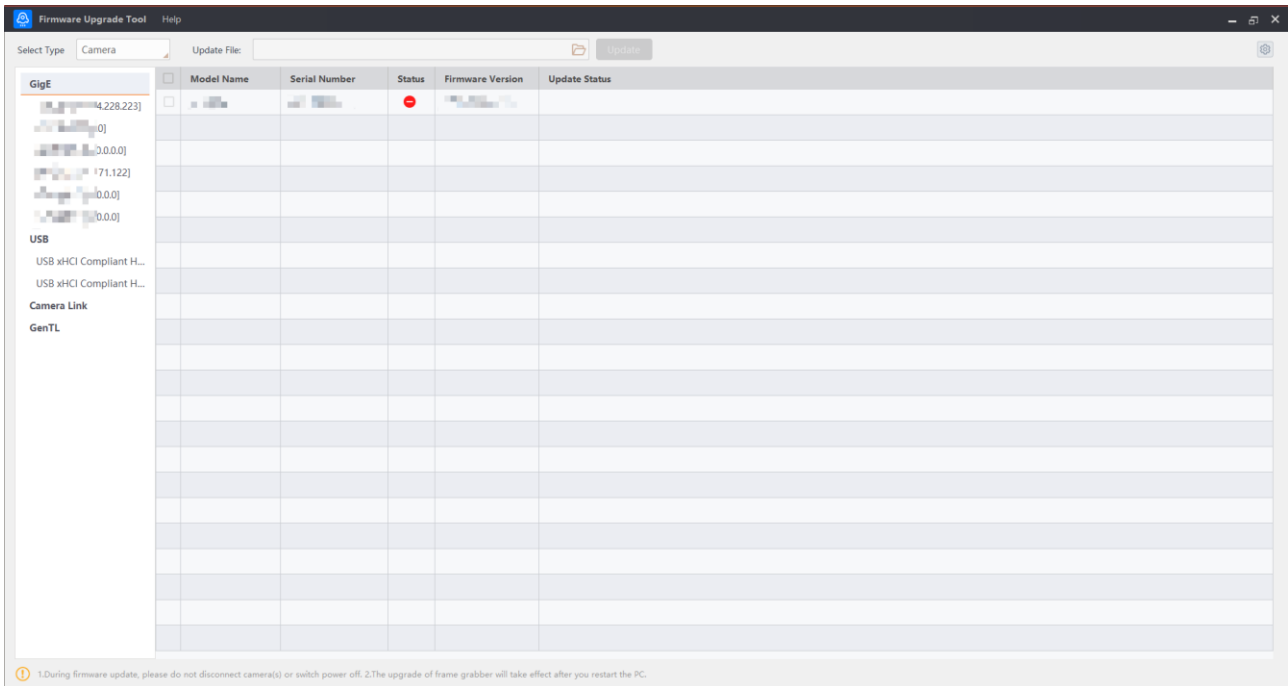

Figure 13-9 Update Firmware

Note

- The device will restart automatically after updating the firmware.
- The firmware updating process may take a few minutes, please wait patiently.
- During firmware updating, do not disconnect the device or switch power off, otherwise it may cause device damage.

13.7 Device Encryption via Dongle Tool

Note

You can contact the technical support to get the dongle tool.

The dongle tool is used to encrypt and decrypt devices for protecting data.

Steps

1. Run the dongle tool, and click **Enumerate** to select a device.
2. Enter a secret key manually, or click **Create Random Secret Key** to generate a secret key automatically.
3. Click **Write Secret Key** to finish device encryption.

4. Enter plaintext that should be no more than 15 characters, and click **Verify** to verify and decrypt the device.

The screenshot shows a software interface for encrypting a device. It is divided into four steps:

- Step 1 :** A button labeled "Enumerate" is next to a dropdown menu.
- Step 2 : Enter Secret Key**: A text input field is present. Below it is a button "Create Random Secret Key". To the right of this button is a note: "The encryption key is composed of 64 hexadecimal digits, or an English string of 32 characters. The user can manually enter or click Create Encryption Key."
- Step 3**: A button labeled "Write Secret Key" is shown.
- Step 4 : Verify and Decrypt**: A text input field contains "Plaintext1234". To its right is a button labeled "Verify".

Below the input fields, a small text block reads: "The plaintext is set to the camera, and the camera returns the encrypted one. The encryption tool decrypts the encryption key, and verifies whether the decrypted result is consistent with the plaintext."

Figure 13-10 Encrypt Device via Dongle Tool

Chapter 14 FAQ (Frequently Asked Question)

14.1 Why the client software cannot list devices?

Table 14-1 Question 1

Possible Cause	Solution
The device is not powered on.	Check the device's power supply connection by observing the device's indicator, and check USB cable connection.
Incorrect USB cable connection.	

14.2 Why device connection fails after the device is listed in the client software?

Table 14-2 Question 2

Possible Cause	Solution
Incorrect installation of the client software.	Install the client software again.
The USB3.0 driver is not installed successfully.	Check the USB driver, and reinstall the driver if it is required.
The device has been connected by other programs.	Disconnect the device with other programs, and reconnect it to the client software.

14.3 Why the live view is black?

Table 14-3 Question 3

Possible Cause	Solution
The device's lens aperture is not removed.	Remove the device's lens aperture.
The device exception occurs.	Power off and restart the device.

14.4 Why the device cannot be triggered although the live

view is normal?

Table 14-4 Question 4

Possible Cause	Solution
The trigger mode is not enabled or the device is not triggered.	Enable the trigger mode and make sure that the selected trigger source matches with the corresponding I/O signal.
Incorrect trigger wiring.	Check if the input of trigger signal and wiring are correct or not.

14.5 Why the device cannot get images required by the algorithm although live view and trigger signal are normal?

Table 14-5 Question 5

Possible Cause	Solution
Incorrect output format of images.	Check the image format required by the algorithm, and adjust the output format of images in the client software.

14.6 Why the device is disconnected during operation?

Table 14-6 Question 6

Possible Cause	Solution
The connection of the USB interface is unstable.	<ul style="list-style-type: none"> It is not recommended to use the adapter to connect the device for data transmission. It is recommended to use the DC power supply. Refer to the device's specification for the voltage range.
The cable is inappropriate.	
There is electrostatic and electromagnetic interference.	

Chapter 15 Revision History

Table 15-1 Revision History

Version	Revision Date	Revision Details
V1.0.0	Dec. 8, 2025	Original version.

Appendix A Device Parameter Index

Here list all parameters of the device mentioned in different sections of this user manual. You can quickly locate parameters in different sections by viewing tables below.

A.1 Device Control

Table A-1 Device Control

Parameters	Section
Device Scan Type	Section Device Control
Device Vendor Name	
Device Model Name	
Device Manufacturer Info	
Device Firmware Version	
Device Serial Number	
Device User ID	
Maximum Device Response Time	
Device Manifest Table Address	
Device SBRM Address	
Device Timestamp	
Device Timestamp Latch	
Device Timestamp Increment	
Device Protocol Endianess	
Device Implementation Endianess	
Device Uptime (s)	
Board Device Type	
USB Interface Selector	
USB Speed Mode	
Device Link Throughput Limit Mode	
Device Link Throughput Limit (Bps)	
Device Link Current Throughput	

Parameters	Section
Device Stream Channel Count	
Device Reset	
Device Temperature Selector	
Device Temperature	
Find Me	
Device Max Throughput (Kbps)	
Device PJ Number	
Device Standby Mode	
Temperature Balance	
Target Temperature	

A.2 Image Format Control

Table A-2 Image Format Control

Parameters	Section
Width Max	Section Set Resolution and ROI
Height Max	
Region Selector	
Width	
Height	
Offset X	
Offset Y	
Reverse X	Section Set Image Reverse
Reverse Y	
Rotation	Section Set Rotation
ADC Bit Depth	Section Set Pixel Format
Pixel Format	
Super Bayer Enable	
Pixel Size	
Image Compression Mode	Section Set Image

Parameters	Section
Image Compression Quality	Compression Mode
Test Pattern Generator Selector	Section Set Test Pattern
Test Pattern	
Binning Mode	Section Set Binning
Binning Selector	
Binning Horizontal	
Binning Vertical	
Decimation Horizontal	Section Set Decimation
Decimation Vertical	

A.3 Acquisition Control

Table A-3 Acquisition Control

Parameters	Section
Acquisition Mode	Section Acquisition Mode
Acquisition Stop	
Acquisition Burst Frame Count	Section Set Frame Rate
Acquisition Frame Rate (Fps)	
Acquisition Frame Rate Control Enable	
Resulting Frame Rate (Fps)	
Trigger Selector	Section Trigger Input
Trigger Mode	
Trigger Software	
Trigger Source	
Trigger Activation	
Trigger Delay (μ s)	
Trigger Cache Enable	
Sensor Shutter Mode	Section Global Shutter and Rolling Shutter
Exposure Mode	Section Set Exposure Mode

Parameters	Section
Exposure Time Mode	
Exposure Time (μs)	
Exposure Auto	
Auto Exposure Time Lower Limit (μs)	
Auto Exposure Time Upper Limit (μs)	
Acquisition Burst Mode	Section Acquisition Burst Mode
Resulting Acquisition Frame Rate	
Resulting Transfer Frame Rate	
Resulting Frame Burst Rate	

A.4 Software Signal Control

Table A-4 Software Signal Control

Parameters	Section
Software Signal Selector	Section Set Counting
Software Signal Trigger	Section Enable Strobe Signal

A.5 Analog Control

Table A-5 Analog Control

Parameters	Section
Gain	Section Set Gain
Gain Auto	
Auto Gain Lower Limit (dB)	
Auto Gain Upper Limit (dB)	
Digital Shift	
Digital Shift Enable	
Sensor Mode	Section Set Sensor Mode
Brightness	Section Set Brightness
Black Level	Section Set Black Level

Parameters	Section
Black Level Enable	
Balance White Auto	Section Set White Balance
AWB Color Temperature Mode	
Balance Ratio Selector	
Balance Ratio	
Gamma	Section Set Gamma Correction
Gamma Selector	
Gamma Enable	
Sharpness	Section Set Sharpness
Sharpness Enable	
Digital Noise Reduction Mode	Section Set Digital Noise Reduction
Denoise Strength	
Noise Correct	
LCE Mode	Section Set LCE Mode
LCE Detail Scale	
Fusion Brightness Slope	
Contrast Ratio	Section Set Contrast Ratio
Contrast Ratio Enable	
Auto Function AOI Selector	Section Set AOI
Auto Function AOI Width	
Auto Function AOI Height	
Auto Function AOI Offset X	
Auto Function AOI Offset Y	
Auto Function AOI Usage Intensity	
Auto Function AOI Usage White Balance	
Spectral Curve	Section Set Automatic Color Correction
Automatic Color Correction	
Color Correction Selector	

A.6 Color Transformation Control

Table A-6 Color Transformation Control

Parameters	Section
CCM Enable	Section Set CCM
Color Transformation Selector	
Color Transformation Enable	
Color Transformation Value Selector	
Color Transformation Value	
Hue	Section Set Hue
Hue Enable	
Saturation	Section Set Saturation
Saturation Enable	

A.7 Super Palette Control

Table A-7 Super Palette Control

Parameters	Section
Super Palette Enable	Section Set Super Palette Control
Super Palette Selector	
Super Palette Hue	
Super Palette Saturation	

A.8 LUT Control

Table A-8 LUT Control

Parameters	Section
LUT Selector	Section Set LUT
LUT Enable	
LUT Index	
LUT Value	

Parameters	Section
LUT Save	
CLUT Enable	Section Set CLUT

A.9 Shading Correction

Table A-9 Shading Correction

Parameters	Section
Shading Selector	Section Set LSC Correction
LSC Calib Select	
LSC Target Gray	
LSC Enable	
Activate Shading	
PFC Enable	Section Set PFC
PFC Window Size	
PFC Edge Threshold	

A.10 Digital IO Control

Table A-10 Digital IO Control

Parameters	Section
Line Selector	Section Trigger Output
Line Mode	
Line Inverter	
Line Status	
Line Status All	
Line Trigger Arm Delay(us)	
Line Debouncer Time (μ s)	
Line Source	
Strobe Enable	
Strobe Line Duration (μ s)	

Parameters	Section
Strobe Line Delay (μs)	
Strobe Line Pre Delay (μs)	

A.11 Counter and Timer Control

Table A-11 Counter and Timer Control

Parameters	Section
Counter Selector	Section Set Trigger Source Section Set Counting
Counter Event Source	
Counter Reset Source	
Counter Reset	
Counter Value	
Counter Current Value	
Counter Status	
Timer Selector	Section Enable Strobe Signal
Timer Duration(μs)	
Timer Delay(μs)	
Timer Reset	
Timer Value	
Timer Current Value	
Timer Status	
Timer Trigger Source	
Timer Trigger Activation	
Timer Trigger Arm Delay(μs)	

A.12 File Access Control

Table A-12 File Access Control

Parameters	Section
File Selector	Section File Access Control

Parameters	Section
File Operation Selector	
File Operation Execute	
File Open Mode	
File Operation Status	
File Operation Result	
File Size(B)	

A.13 Sequencer Control

Table A-13 Sequencer Control

Parameters	Section
Sequencer Mode	Section Set Sequencer
Sequencer Configuration Mode	
Sequencer Feature Selector	
Sequencer Feature Enable	
Sequencer Restart	
Sequencer Set Total Number	
Sequencer Set Selector	
Sequencer Set Load	
Sequencer Set Save	
Sequencer Set Frame Count	
Sequencer Set Active	

A.14 Event Control

Table A-14 Event Control

Parameters	Section
Event Selector	Section Set Event Control
Event Notification	

A.15 Chunk Data Control

Table A-15 Chunk Data Control

Parameters	Section
Chunk Mode Active	Section Embedded Information
Chunk Selector	
Chunk Enable	

A.16 Transport Layer Control

Table A-16 Transport Layer Control

Parameters	Section
Payload Size	Section Transport Layer Control
GenCP Version Major	
GenCP Version Minor	
U3V Version Major	
U3V Version Minor	
U3VCP SIRM Available	
U3VCP EIRM Available	
U3VCP IIDC2 Available	
U3V Max Command Transfer Length	
U3V Max Acknowledge Transfer Length	
U3V Number of Stream Channels	
U3V SIRM Address	
U3V SIRM Length	
U3V EIRM Address	
U3V EIRM Length	
U3V Current Speed	

A.17 Stream Control

Table A-17 Transfer Control

Parameters	Section
U3V SI Payload Transfer Size	Section U3V Protocol Control
U3V SI Payload Transfer Count	
U3V SI Payload FinalTransfer1 Size	
U3V SI Payload FinalTransfer2 Size	

A.18 Transfer Control

Table A-18 Transfer Control

Parameters	Section
Transfer Selector	Section Set Transfer Control
Transfer Control Mode	
Transfer Passive Enable	
Transfer Operation Mode	
Transfer Queue Max Block Count	
Transfer Queue Current Block Count	
Transfer Queue Over Flow Count	
Transfer Queue Mode	

A.19 User Set Control

Table A-19 User Set Control

Parameters	Section
User Set Current	Section User Set Customization
User Set Selector	
User Set Load	
User Set Save	
User Set Save Status	
User Set Default	



HIKROBOT

SHAPE OUR FUTURE INTELLIGENTLY

Hikrobot Co., Ltd.

Tel: 400-989-7998

Website: <https://en.hikrobotics.com/>

UD44851B