



38U Series DMK 38UX540

- IMX540 CMOS Pregius S Sensor
- 24.5 MP
- USB3 Vision / UVC compliant
- Trigger and I/Os
- C mount



The 38U series camera DMK 38UX540 with a Sony IMX540 sensor delivers 15 frames per second with a resolution of 5320x4600 (24.5 MP).

With resolutions up to 24.5 MP, the 38U Series industrial cameras deliver high resolution and exceptional image quality for demanding manufacturing and factory automation applications. 38U Series cameras combine USB's superior data transfer rates with advanced feature sets including USB-C connector, external trigger control, advanced readout functions as well as image and color processing.

The USB3 Vision standard allows for rapid integration into new and existing applications via The Imaging Source's [IC Imaging Control 4 SDK](#) as well as most other third-party image processing libraries.

Note: This Data Sheet is intended to provide a summary overview for an individual camera model. The Imaging Source's website also offers information on spectral sensitivity, dimensional diagrams, sensor data sheets, STEP files as well as our full product catalog. For comprehensive technical information, please refer to the Technical Reference Manual specific to each camera model.

www.theimagingsource.com



1 Quick Facts

General	
Vision Standard	USB3 Vision (UVC compliant)
Dynamic Range	12 bit
Resolution	5320x4600
Frame Rate at Full Resolution	15

Optical Interface	
IR-Cut filter	No
Sensor Type	Sony IMX540-AAMJ-C
Shutter Type	Global
Sensor Format	1.2 inch
Pixel Size	2.74 μm
Lens Mount	C (CS optional)

Electrical Interface	
Interface	USB 3.1gen1
Supply Voltage	4.75 VDC to 5.25 VDC
Current Consumption	approx 880 mA @ 5 VDC
I/O Connector	12-pin connector for trigger and strobe or general purpose input/output

Mechanical Data	
Dimensions	H: 29 mm, W: 44 mm, L: 60 mm
Mass	110 g

Environmental Conditions	
Housing Temperature (operating)	-5 °C to 50 °C
Temperature (storage)	-20 °C to 80 °C
Humidity (operating)	20 % to 80 % (non-condensing)
Humidity (storage)	20 % to 95 % (non-condensing)



Dimensional Diagrams

2 Dimensional Diagrams

2.1 DMK 38UX540 C-Mount without Tripod Adapter

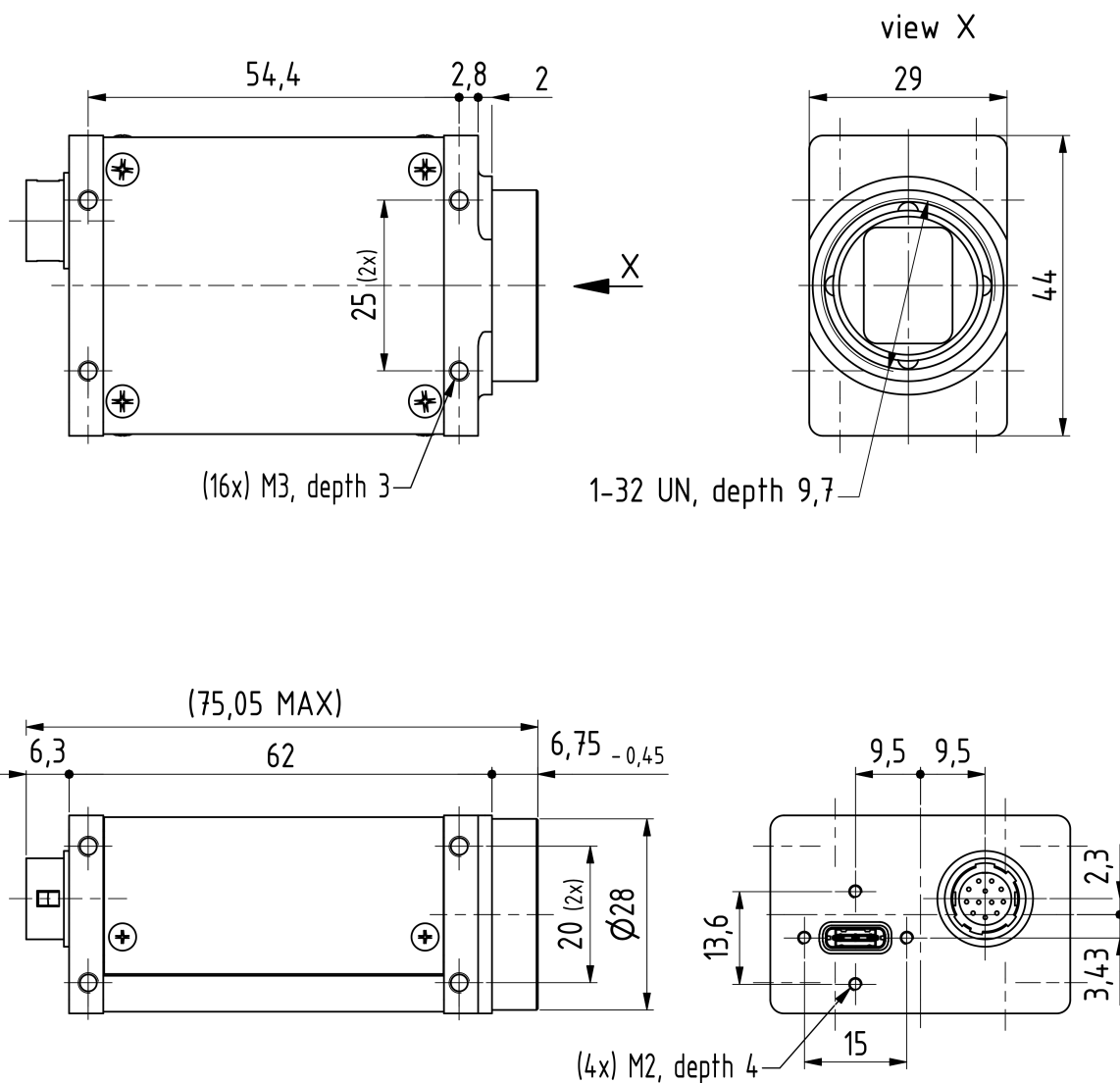

Dimensions: mm
Tolerances: DIN ISO 2768-f





3 Spectral Characteristics

3.1 Spectral Sensitivity - IMX540-AAMJ-C

